

INFINITY

ENGINEERED PRODUCTS



SUPER-CUSHION[®] AIR SPRINGS

FOR TRUCK, TRAILER AND BUS SUSPENSIONS
AND FOR CAB AND SEAT SPRINGS

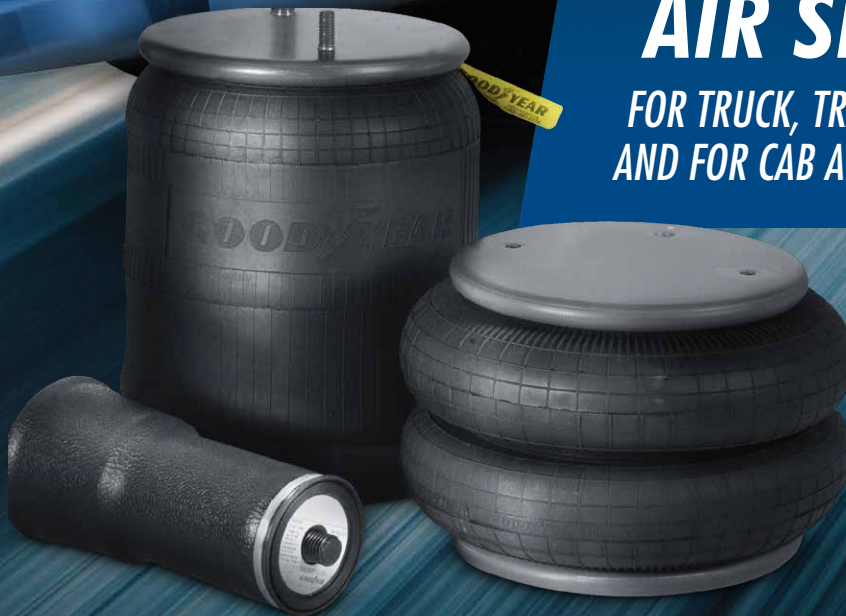

GOODYEAR
AIR SPRINGS

INFINITY
ENGINEERED PRODUCTS



INFINITY ENGINEERED PRODUCTS AIR SUSPENSION FEATURES & BENEFITS

TOP BEAD PLATE THICKNESS

- Reduced leakage at crimp — Longer Life

OZONE RESISTANCE — 2.4 TIMES PROTECTIVE MATERIALS

- Reduced Cracking — Longer Life

EPOXY POWDER COATED PISTONS (STEEL)

- Reduced Bellow Wear — Longer Life

EXTEND-AIR: DOUBLE WRAPPED FABRIC

- Reduced DOT Downtime (Up to 20 Times Life)

TYVEK TAG WITH PART NUMBER

- Easy Identification

GOODYEAR & INFINITY ENGINEERED PRODUCTS BRANDS

- Customer Confidence

4 YEAR WARRANTY

- Longest in the Industry

INFINITY ENGINEERED PRODUCTS SALES TEAM

- Sales Support & Training

TABLE OF CONTENTS

AIR SPRING PRODUCT INFORMATION	PAGE
Super-Cushion® Air Springs for Trucks, Trailers, and Buses.	2
Components of Super-Cushion Air Springs	3
Unique Product Identification System.	4
How to Choose the Correct Replacement Air Spring	5
Air Spring Identification	6-7
Air Spring Installation	8-9
Air Suspension Vehicle Maintenance Checklist.	10
Selected Non-warrantable Conditions.	11-13
NEW ADDITIONS	
2018 New Air Springs Additions	14
IDENTIFICATION & APPLICATION INFORMATION	
Bellows.	16-45
Rolling Lobes.	46-123
Sleeves.	126-137
FLEX MEMBER INDEX	138-141
FIRESTONE FLEX MEMBER CROSS REFERENCE	142-143
PISTON INDEX	
Pistons for Rolling Lobe Air Springs	144-147
CROSS REFERENCE INFORMATION	
Competitors to Super-Cushion	148-172
TERMS AND CONDITIONS	174-175





SUPER-CUSHION[®] **AIR SPRINGS FOR TRUCKS, TRAILERS, AND BUSES**

Super-Cushion air springs for trucks, trailers buses, and cab & seat springs protect cargo, provide constant-level hauling, and deliver long, trouble-free service. Super-Cushion air springs give your trucks, trailers and buses a new high in productivity and long life. They offer a quiet, cushioned ride. Truck, trailer and bus bodies last longer than with steel springs because there is less vibration. The driver rides in greater comfort, becomes less fatigued and stays more alert. Plus cargo has better protection from shock and vibration. Whenever you want to add an axle, Super-Cushion air springs fit right in. Super-Cushion air springs, when used with leveling valves, also maintain consistent trim regardless of the load. That means clearance heights remain constant, and that trailer floors are flush with loading dock floors for ease of loading and unloading. For driver comfort, load cushioning, and long life for your trucks, trailers, bus, and cab and seat springs specify Goodyear Engineered Products Super-Cushion air springs.



COMPONENTS OF SUPER-CUSHION[®] AIR SPRINGS

ROLLING LOBE AIR SPRING (1R DESIGN)

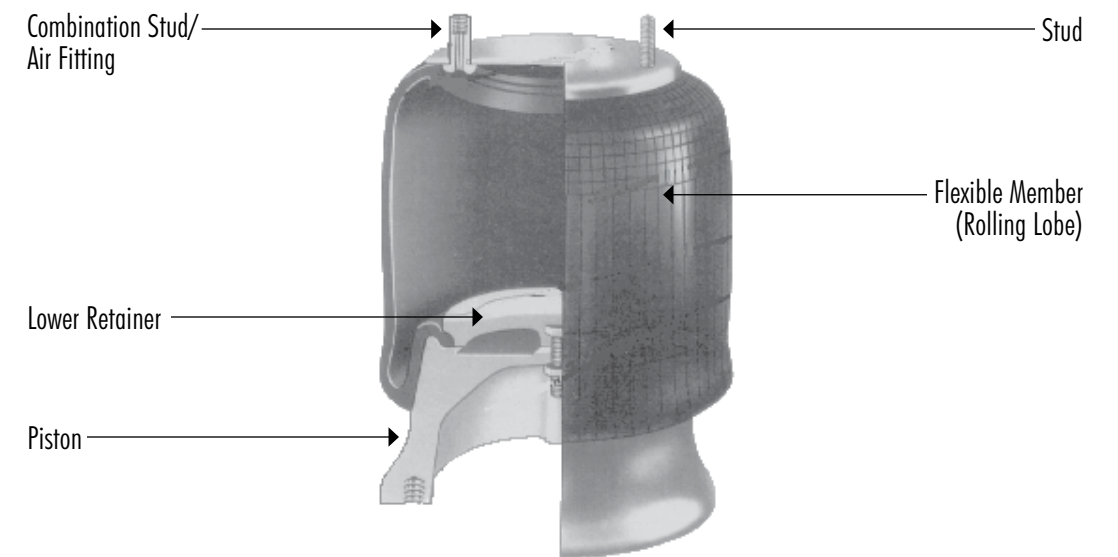

DOUBLE CONVOLUTION AIR SPRING (2B DESIGN)

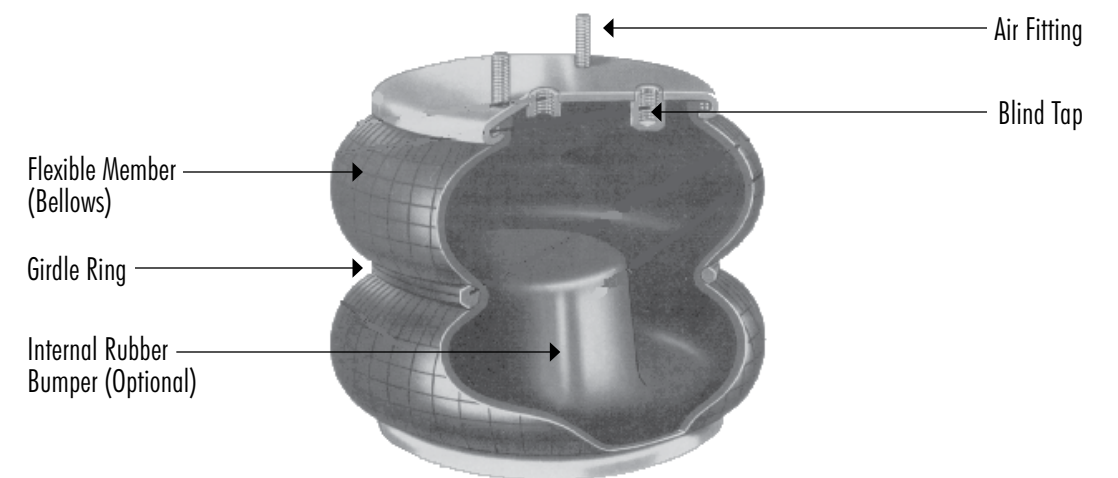

UNIQUE PRODUCT IDENTIFICATION SYSTEM

The Super-Cushion air spring assembly part number consists of the Product Description and the Assembly Number. Elements of this system are shown in the following example for ordering a 2B12-300 Assembly:

2 B 12 - 300

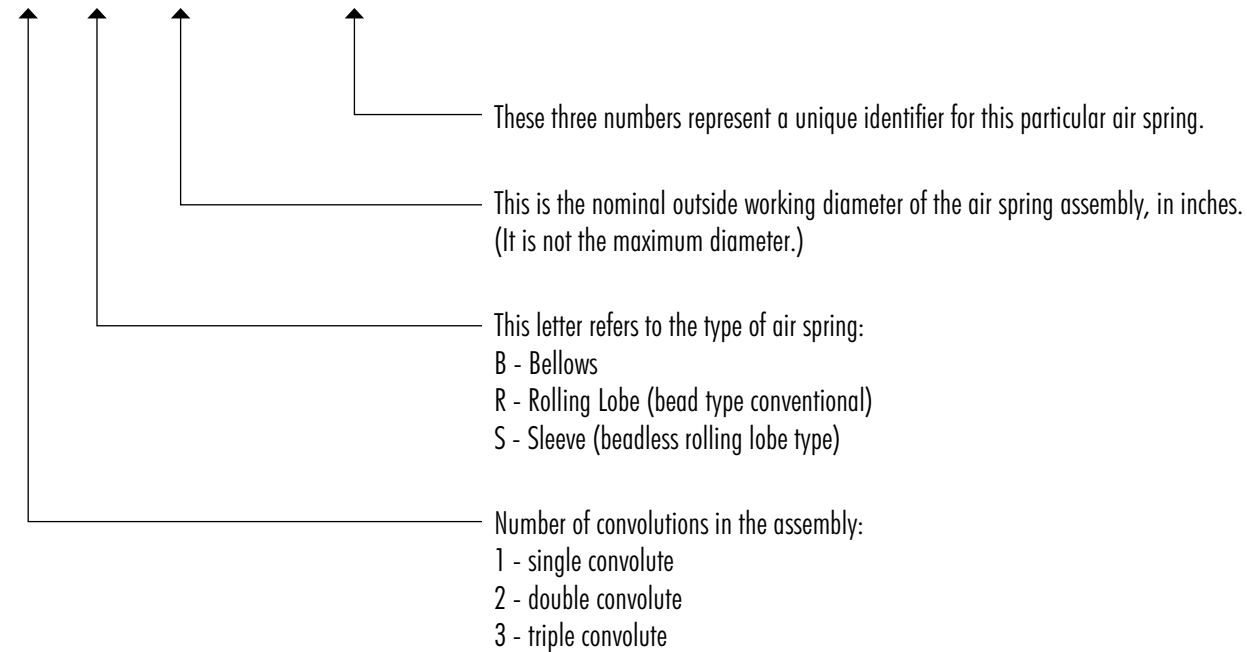

HOW TO CHOOSE THE CORRECT REPLACEMENT AIR SPRING

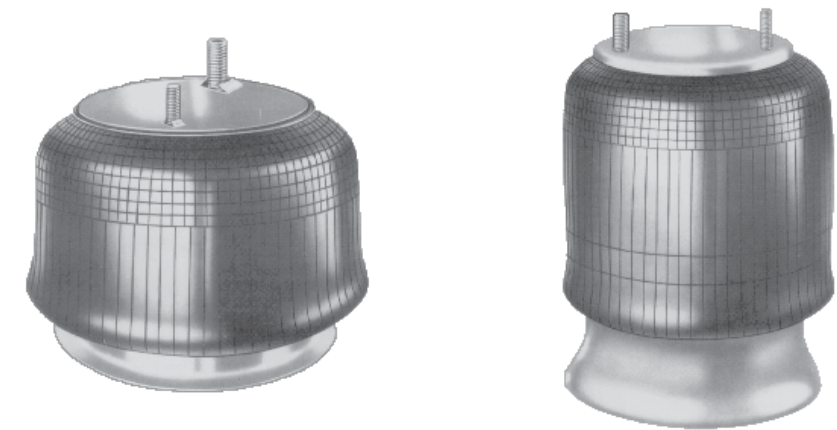

Many air springs appear to be similar in design and size at first glance. However, differences in the manufacturing techniques used for similar looking air springs may create substantial differences in operating dimensions. Specifically, the inflated (or operating) diameters of seemingly identical air springs will vary depending on the angle of the reinforcing fabric used in the flexible member.

For example, air spring models 1R12-092 and 1R13-039 appear very similar when first examined. However, the 1R12-092 model will inflate (operate) on vehicle at approximately 12" diameter, while the 1R13-039 model will operate at 13" diameter. In a substitution of the 1R13-039 air spring for the 1R12-092 in a truck trailer suspension, the larger air spring inflated diameter would most likely rub on another suspension component (such as a tire, shock absorber, or bracket) and cause failure within a few miles.

Air springs with interference type failures will not be considered for warranty claims. Be sure to select the correct replacement!

To select the proper Goodyear Engineered Products Super-Cushion® replacement air spring, use the procedure on the next page.

CAUTION: Numbers molded on the rubber bag (flexible member) are NOT the assembly part numbers. Bags with the same numbers are used with different combinations of top and bottom metals. They may or may not have an internal rubber bumper.

AIR SPRING IDENTIFICATION

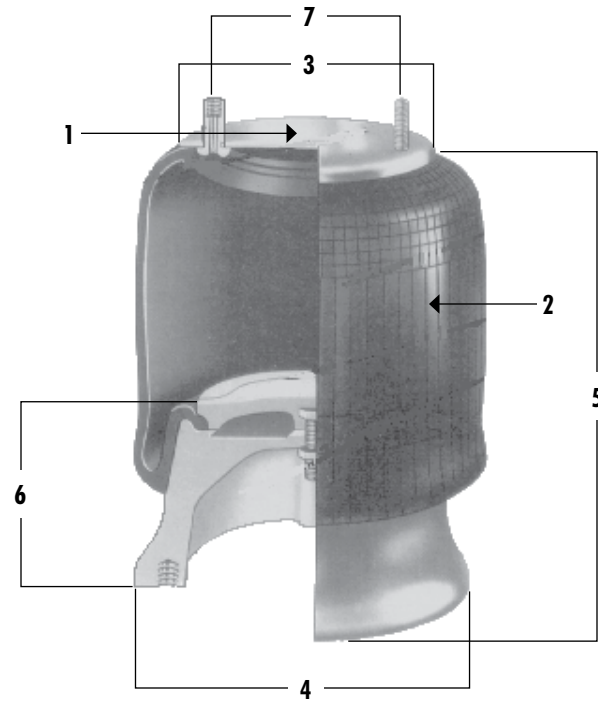

1. Start with the original equipment or aftermarket part number. It is usually located on a label affixed to the top plate of the air spring. If it is a Goodyear Engineered Products part number, simply double check the product photo in the main body of the catalog. If you have an O.E. number or a Firestone number look in the cross-reference section.
2. If the O.E. part number or aftermarket part number is unknown you should begin your search with the bellows number. The number is molded into the rubber part of the air spring. Once identified you can narrow down the choices in the Flexible Members Index section.
3. Measure the width of the top plate and make a note of the bolt pattern or taps.
4. Measure the width of the piston or bottom bead plate and make a note how the bolt pattern is oriented compared to the bolts on the top plate (Inline or Rotated). The view of this orientation should appear as if you are looking directly through a clear drinking glass from the top to bottom. This is how the catalog illustrations are drawn.
5. Measure the height of the air spring with no air pressure from the top plate to the bottom of the piston. This is the extended height.
6. Compress the bag as far as possible with no air pressure and measure the height. This is the compressed height or minimum height.
7. Measure the distance from center to center of each bolt on the top and bottom of the air spring.

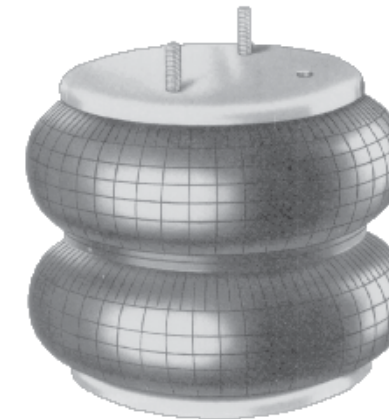

2B DESIGN

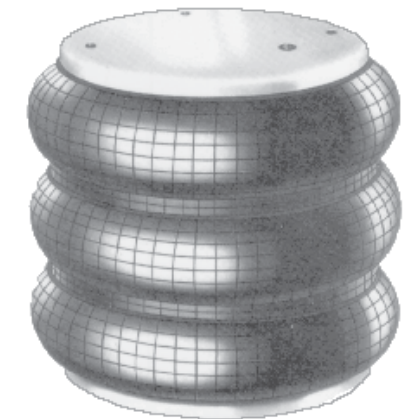

3B DESIGN

NOTES: If the air spring you are replacing has studs (retainers) attached to the top or bottom plate, and the Goodyear Engineered Products Super-Cushion® air spring is identical except that it has recessed, blind taps, use the optional shoulder studs 578-92-9-056. (Pictured to the right.) Screw these into the plate using Locktite #271, or equivalent, thread lock to insure that the studs do not loosen in service.

If you wish to use cap screws or your own bolts to attach air springs with recessed blind nuts to the suspension, the screw must have 3/8-16 threads and must extend no more than 0.562" into the blind taps. Deeper penetration will cause the new air spring to leak and it cannot be repaired satisfactorily.

Air springs with damaged blind taps cannot be considered for warranty claims.

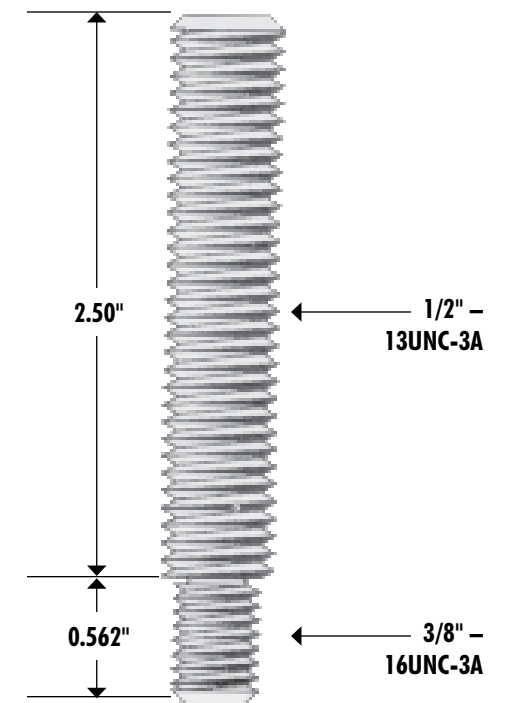

SHOULDER STUD
578-92-9-056



AIR SPRING INSTALLATION

Before you start installing air springs, make sure you have all the necessary tools and equipment to perform the repair safely. Familiarize yourself with the suspension on which you are performing the repair by reviewing the manufacturer's service guide. If you are in doubt about something, ask for assistance from a qualified suspension specialist, the suspension manufacturer or the air spring manufacturer; it can save you a lot of time and aggravation later in the job.

Here are important tips to remember when installing a new unit:

- When disconnecting the leveling valve linkage, check for bent or broken link-age; if you find any, replace the damaged parts.
- Check shock absorbers for possible replacement. There are usually two warning signs indicating a worn shock. If it can be easily compressed or extended, it is time for a new unit. Also, if the vehicle has just been brought in for service, the shock should be warm to the touch. If not, it needs to be replaced. Remember, proper shock maintenance is one of the keys to long air spring life.
- Once the air lines are disconnected, check the line for cracks or damage. Also check for loose fittings, and replace any worn components.
- Some times the cause of air spring failure is visible and/or readily apparent; other times it is not. When it is not, inspect the air spring after you have removed it to determine the cause of failure and then correct the root cause of the problem.
- With the air spring removed, other parts of the air suspension become more accessible. Check for wear or damage of the frame hangers, trailing arm bushings, torque rods, the trailing arms and the air spring mounts. Again, replace components where necessary.
- Also check the area around the air spring mounting to ensure there are not any obstacles or sharp edges that can damage the new air spring.
- Before installing the new unit, clean the air spring mounting plates to ensure proper attachment to the suspension.
- Always use new attaching bolts for the installation. Old bolts should never be reused since they may fail.
- Check the leveling arm for proper operation. Under load, the leveling arm should move from the neutral position up to the intake position. This lets air into the springs, which brings the arm back to the neutral position. When the load is removed, the leveling arm should move down to the exhaust position. That opens the exhaust valve, allowing air to escape until the arm returns to the neutral position.



AIR SPRING INSTALLATION

NOTES

Add Shoulder Stud #578-92-9-056 where required.

SAFETY & LONGEVITY RULES

1. Use Goodyear Engineered Products Flexible Members on Goodyear Engineered Product Pistons Only.
2. Replace ALL air springs on each axle instead of just one.

Following Rule 1 will prevent component failure due to interference with other suspension parts or other truck/trailer components.

Following Rule 2 will give equal riding heights & bounce response to insure a stable and safer ride.

Any old air spring assemblies which are still serviceable could be carried.

AIR SPRING TORQUE REQUIREMENTS

The following values are considered to be the maximum allowable torque for the designated mounting hardware.

MAXIMUM TORQUE (FT. LBS.)

3/8" - UNC BLIND TAPS	25
1/2" - UNC BOLTOR STUD	25
3/4" - UNC STUD	55
3/4" - UNF COMBO STUD	50

AIR FITTINGS

1/4" NPTF	20
1/2" NPTF	20
3/4" NPTF	20

Air springs failing due to over torqueing will NOT be considered for warranty claims.

AIR SUSPENSION MAINTENANCE VEHICLE CHECK-LIST

- Check air lines and fittings for leaks: rubbing on air spring.
- Check proper clearance around air spring when inflated. Generally, a minimum of 1-1/2" will allow for the increased diameter which occurs in heavy jounce.
- Periodically, check suspension for proper ride height. This dimension should be maintained +/- 1/4" to protect the springs and shocks from over-extension or frequent bottoming out of the suspension.
- When doing routine vehicle maintenance, block up the suspension and check for irregular wear or material build-up on the flexmember. Clean, if necessary, using a non-petroleum based cleaning solution.
- Check rolling lobe piston for material build-up. Hardened debris on the piston will shorten spring life and should be removed as part of your regular maintenance.
- Check shock absorbers for any signs of leaking hydraulic fluid, broken end connections, worn bushings or cylinders, and over extension.
- Periodically, check nuts and bolts for proper torque. See manufacturer's manual for specific recommendations.
- Check height control valve to see that it is functioning properly. Clean or replace, if necessary. A properly maintained valve will save hundreds of dollars in unneeded maintenance expense.

Routine inspection of all of the above, according to a predetermined mileage maintenance schedule will extend the life of your vehicle and reduce your overall maintenance expense.

SELECTED NON-WARRANTABLE CONDITIONS

OVER-EXTENSION

- Eventual tearing away of the bellows from the top plate or the bottom piston.
- The top plate may appear convex.
- Commonly seen on lift axle applications, particularly on trucks and tractors used in severe on/off road service such as construction, logging, or quarrying.
- Results from operation of the air spring beyond its rated maximum extended height or long-term operation at or near its maximum extended height.



OVER-EXTENSION

Possible causes:

- Improper restraint of the downward travel of the axle that allows the air spring to operate beyond its rated maximum extended height.
- The ride position is too high due to improper adjustment or improper functioning of the leveling valve.
 - Can result in long-term operation of the air spring at or near its rated maximum extended height.
- Shock absorbers are not functioning properly, are missing or are improperly sized.
- Incorrect air spring for application (too short).

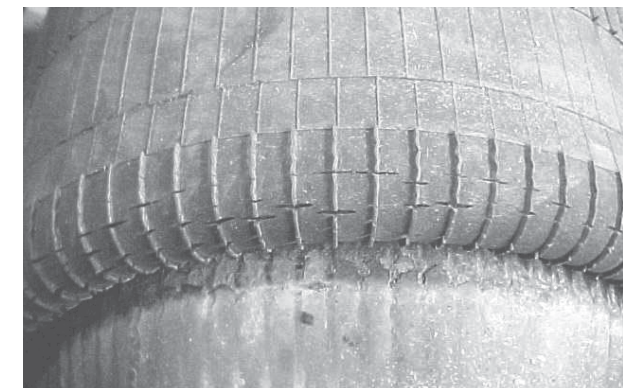

NORMAL FATIGUE

NORMAL CYCLE FATIGUE

- Fatigue cracks will appear on the outer surface of the rubber as a normal part of the aging process.
- Minor cracks are not ordinarily a cause for removal.
- The air spring will still function properly provided there is no air leakage.

SELECTED NON-WARRANTABLE CONDITIONS

RUBBER DAMAGE FROM CHEMICALS

- Grease and oil are common examples that can cause this condition after prolonged contact with the rubber flexible member.

Possible causes:

- Excessive oil in the air supply.
- Excessive greasing of universal joints.
- Excessive greasing of the fifth wheel.
- Leaking seals in suspension components.
- Use of petroleum based cleaners on the air spring (use only soap and water for cleaning).



DAMAGE FROM CHEMICALS

CORROSION AND IMPACTS

- Deterioration of the top plate or piston.

Possible causes:

- Chemical exposure.
- Road debris being flung into the piston causing a crack.
- Pitting from salt.
- Excessive oil or water in the air supply.
- Build-up of debris on the piston, top plate, or girdle hoops (keep clean with soap and water).

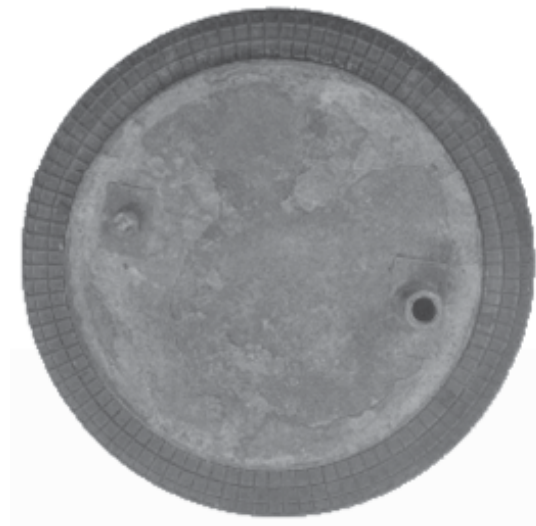

CORROSION AND IMPACTS

SELECTED NON-WARRANTABLE CONDITIONS

EXTERNAL ABRASION

- A hole rubbed into the side of the bellows.

Possible causes:

- Bellows contact with components on the vehicle (such as air lines).
- Road dirt and debris.
- Worn or failed parts in the suspension.
 - Worn bushing
 - Broken shock
 - Misalignment
- Leak or pinch in air line causing spring to be under-inflated.



ABRASION

NEW AIR SPRINGS

NEW PART #	FIRESTONE PART #	COMPETITOR PART #	TYPE	PAGE #
1R12-1097	W01-358-8864	Peterbilt/Paccar C81-1011	Rolling Lobe Air Spring	103
1S4-235	W02-358-7155	Paccar 20-19036 Peterbilt R81-6002	Cab Spring	129
1S5-190	W02-358-7093	Peterbilt 29-06016	Cab Spring	136
1S4-234	W02-358-7132 (formerly W02-358-6754)	Peterbilt R81-6003	Cab Spring	129
1R12-1204	W01-358-8813	Kenworth C81-1003 Peterbilt C81-6000	Rolling Lobe Air Spring	103
1R11-292	W01-358-9626	Hendrickson Trailer S23720	Rolling Lobe Air Spring	62
1R12-1093	W01-358-9663	Hendrickson 60271-2	Rolling Lobe Air Spring	102
1R12-1094	W01-358-8203	Gillig LF Rear 82-19159-000	Rolling Lobe Air Spring	100
1R12-1095	W01-358-9697	Holland 90557329	Rolling Lobe Air Spring	102
2B9-495	W01-358-7897	Hendrickson S23114	Bellows Air Spring	27

NOTES

AIR SPRING BELLOWS

BELLOWS NUMBER	SIDE VIEW WITH EXTENDED AND COMPRESSED HEIGHT	UPPER MOUNTING VIEW	LOWER MOUNTING VIEW	MANUFACTURER NUMBERS
556-33-8-335	3B14-450 	ASA-92-028 	ASA-92-6-013 	AUTOMANN ABSP3B32RA-7845 FIRESTONE W013587845
556-33-8-335	3B14-451 	ASA-92-8-100 	ASA-92-6-015 	AUTOMANN ABSP3B32RA-7846 CONTI 64582 FT 530-35 456 FIRESTONE 7846 W013587846 HENDRICKSON S-7853 TRIANGLE 4456
556-33-8-335	3B14-452 	ASA-92-8-174 	ASA-92-6-056 	AUTOMANN ABSP3B32RA-7850 CONTI 64580 FT 530-35 441 FIRESTONE 7850 W013587850 HISTEER 10301 SUSPENSIONS INC. 200177 TRIANGLE 4441 WATSON & CHALIN AS-0086
556-33-8-335	3B14-453 	ASA-92-8-028 	ASA-92-6-013 	AUTOMANN ABSP3B32RA-7838 CONTI 64576 FT 530-35 436 FIRESTONE 7838 W013587838
556-33-8-335	3B14-455 OBSOLETE 	ASA-92-8-031 	ASA-92-6-113 	

- Bolt or Stud – 1/2-13 or 1/2-20
- ⊗ Air Fitting – 1/4 NPTF
- ⊙ Stud – 3/4-10
- ⊕ Tapped Hole on Top Retainers – 3/8-16, on Pistons – 1/2-13
- ⊗ Air Fitting – 1/2 NPTF or 3/8 NPTF
- ⊙ Combination Stud Air Fitting: Stud – 3/4-16, Air Fitting – 1/4 NPTF

AIR SPRING BELLOWS

BELLOWS NUMBER	SIDE VIEW WITH EXTENDED AND COMPRESSED HEIGHT	UPPER MOUNTING VIEW	LOWER MOUNTING VIEW	MANUFACTURER NUMBERS
556-33-8-335	3B14-456 	ASA-92-8-031 	ASA-92-6-015 	AUTOMANN ABSP3B32RA-7839 FIRESTONE 7839
556-33-8-335	3B14-457 	ASA-92-8-100 	ASA-92-6-015 	AUTOMANN ABSP3B32RA-7843 CONTI 64581 FT 530-35 455 FIRESTONE 7843 W013587843
556-33-8-335	3B14-459 	ASA-92-8-100 	ASA-92-6-050 	AUTOMANN ABSP3B32RA-7847 CONTI 64583 FT 530-35 457 FIRESTONE 7847 W013587847
556-33-8-335	3B14-462 	ASA-92-8-031 	ASA-92-6-013 	AUTOMANN ABSP3B32RA-7855 FIRESTONE 7855
556-33-8-335	3B14-463 	ASA-92-8-174 	ASA-92-6-013 	AUTOMANN ABSP3B32RA-7859 FIRESTONE 7859

- Bolt or Stud – 1/2-13 or 1/2-20
- ⊗ Air Fitting – 1/4 NPTF
- ⊙ Stud – 3/4-10
- ⊕ Tapped Hole on Top Retainers – 3/8-16, on Pistons – 1/2-13
- ⊗ Air Fitting – 1/2 NPTF or 3/8 NPTF
- ⊙ Combination Stud Air Fitting: Stud – 3/4-16, Air Fitting – 1/4 NPTF

AIR SPRING BELLOWS

AIR SPRING BELLOWS

BELLOWS NUMBER	SIDE VIEW WITH EXTENDED AND COMPRESSED HEIGHT	UPPER MOUNTING VIEW	LOWER MOUNTING VIEW	MANUFACTURER NUMBERS
556-33-8-335	3B14-464 	ASA-92-8-100 	ASA-92-6-013 	AUTOMANN ABSP3B32RA-7862 CONTI 64587 FT 530-35 534 FIRESTONE 7862 W013587862 TRP AS78620
578-23-8-329	2B14-469 	ASA-92-8-352 	ASA-92-6-016 	NEWAY 905-57-257
578-91-3-301	1B12-301 	ASA-92-8-002 	ASA-92-6-002 	AUTOMANN ABSP1B22A-7009 CONTI 64595 FS 330-11 468 FIRESTONE 7009 W013587009 NEWAY 905-57-002 TRIANGLE 4468 TRP AS70090
578-91-3-301	1B12-305 	ASA-92-8-006 	ASA-92-6-002 	AUTOMANN ABSP2B22RA-7443 FIRESTONE 6920 7043 W013586920 W013587043
578-91-3-301	1B12-306 	ASA-92-8-002 	ASA-92-6-002 	

- Bolt or Stud – 1/2-13 or 1/2-20
- ⊗ Air Fitting – 1/4 NPTF
- ⊙ Stud – 3/4-10
- ⊕ Tapped Hole on Top Retainers – 3/8-16, on Pistons – 1/2-13
- ⊗ Air Fitting – 1/2 NPTF or 3/8 NPTF
- ⊙ Combination Stud Air Fitting: Stud – 3/4-16, Air Fitting – 1/4 NPTF

AIR SPRING BELLOWS

BELLOWS NUMBER	SIDE VIEW WITH EXTENDED AND COMPRESSED HEIGHT	UPPER MOUNTING VIEW	LOWER MOUNTING VIEW	MANUFACTURER NUMBERS
578-91-3-301	1B12-313 	ASA-92-8-002 	ASA-92-6-002 	AUTOMANN ABSP1B22A-7008 CONTI 64596 FS 330-11 474 FIRESTONE W013587008
578-91-3-301	1B12-322 	ASB-92-8-164 	ASA-92-6-002 	AUTOMANN ABSP1B22A-6994 CONTI 64594 FS 330-11 467
578-91-3-310	2B12-305 	ASA-92-8-026 	ASA-92-6-002 	AUTOMANN ABSP2B22RA-7443 CONTI 64531 FD 330-22 323 DAYTON 354-7443 FIRESTONE 7443 W013587443 GRANNING 1218 1589 INT'L/NAVISTAR 554786C1 LOAD GUARD SC2026 RIDEWELL 1003587443C S-2683-C TRIANGLE 4323 TRP AS74430 WATSON & CHALIN AS-0027
578-91-3-310	2B12-317 	ASA-92-8-004 	ASA-92-6-004 	AUTOMANN ABSP2B22RA-7499 CONTI 64539 FD 330-30 502 FIRESTONE 7499 W013587499 SUSPENSIONS INC. 201602 TRIANGLE 4502
578-91-3-310	2B12-324 	ASA-92-8-017 	ASA-92-6-002 	AUTOMANN ABSP2B22RA-7447 ABSP2B22RA-7790 CONTI 64532 FD 330-30 340 DAYTON 354-7447 E-Z RIDE 8030150 FIRESTONE 7447 7790 FIRESTONE CONTI W013587447 W013587790 HENDRICKSON 1475 8-6242 INT'L/NAVISTAR 554790C1 LOAD GUARD SC2028 TRIANGLE 4340 4513

- Bolt or Stud – 1/2-13 or 1/2-20
- ⊗ Air Fitting – 1/4 NPTF
- ⊙ Stud – 3/4-10
- ⊕ Tapped Hole on Top Retainers – 3/8-16, on Pistons – 1/2-13
- ⊗ Air Fitting – 1/2 NPTF or 3/8 NPTF
- ⊙ Combination Stud Air Fitting: Stud – 3/4-16, Air Fitting – 1/4 NPTF

AIR SPRING BELLOWS

AIR SPRING BELLOWS

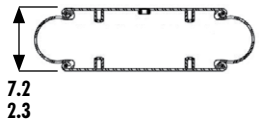
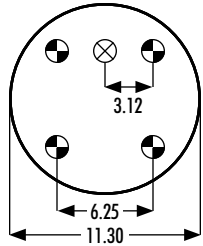
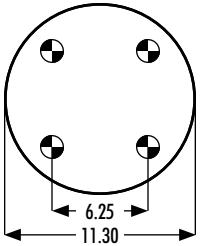
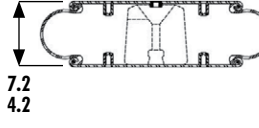
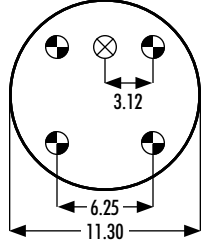
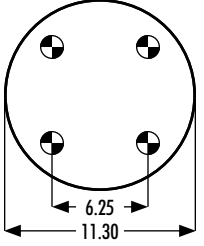
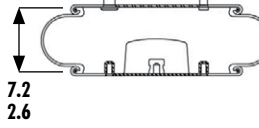
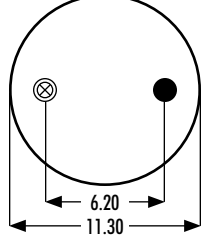
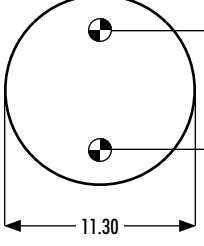
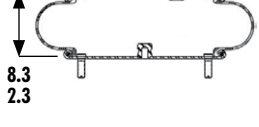
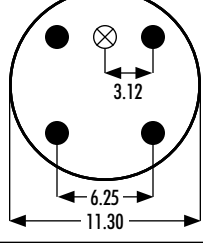
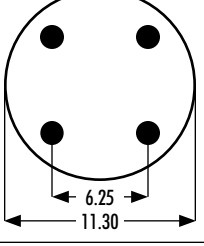
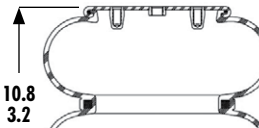
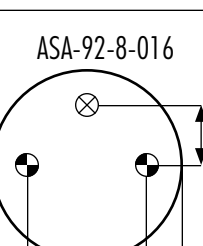
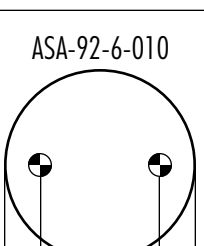
BELLOWS NUMBER	SIDE VIEW WITH EXTENDED AND COMPRESSED HEIGHT	UPPER MOUNTING VIEW	LOWER MOUNTING VIEW	MANUFACTURER NUMBERS
578-91-3-351	1B14-350 	ASA-92-8-028 	ASA-92-6-013 	AUTOMANN ABSP1B34A-7103 CONTI 64523 FS 530-14 442 FIRESTONE 7103 W013587103 PEERLESS 0550-00015 TRIANGLE 4442 TRP AS71030
578-91-3-351	1B14-351 	ASA-92-8-028 	ASA-92-6-013 	AMERICAN CARRIER 8003007 AUTOMANN ABSP1B34A-7104 CONTI 64525 FS 530-14 447 FIRESTONE 7105 W013587104 W013587105 TRIANGLE 4447 TRP AS71050
578-91-3-351	1B14-373 	ASA-92-8-174 	ASA-92-6-056 	
578-91-3-352	1B14-358 	ASA-92-8-031 	ASA-92-6-015 	AUTOMANN ABSP1B34A-7112 CONTI 64521 FS 530-14 339 DAYTON 354-7112 FIRESTONE 7112 W013587112 INT'L/NAVISTAR 554782C1 LOAD GUARD SC2012 NEWAY 905-57-026 905-57-028 905-57-041 AR-1834 RIDEWELL 1003587112C S-3364-C TRIANGLE 4339
578-92-3-202	2B9-200 	ASA-92-8-016 	ASA-92-6-010 	AUTOMANN ABSP2B12R-6910 CONTI 64267 FD 200-19 320 DAYTON 354-6910 DINA A-8127-19 FIRESTONE 6910 W013586910 GRANNING 1371 HDA PMA86-6910B HENDRICKSON 45843-3 B-8768 INT'L/NAVISTAR 554783C1 LOAD GUARD SC2011 MASA 227138412 PREVOST 63-0173 R&S TRUCK & BODY 1027405 RIDEWELL 1003586910C S-4512-C SPRINGRIDE 289-492 TAURUS AS218-6910 TRIANGLE 4320 TRP AS69100 WATSON & CHALIN AS-0001

AIR SPRING BELLOWS

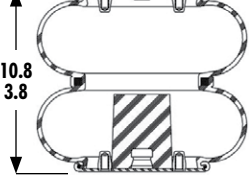
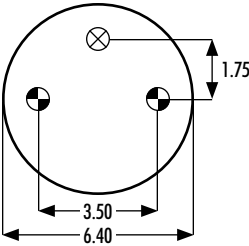
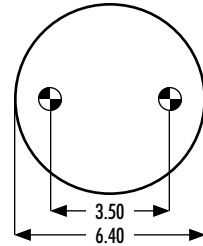
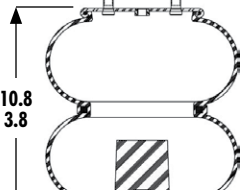
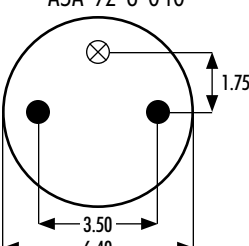
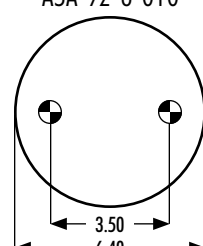
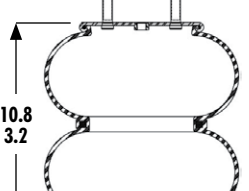
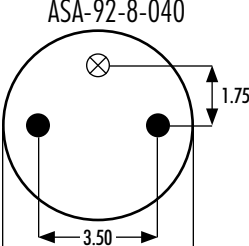
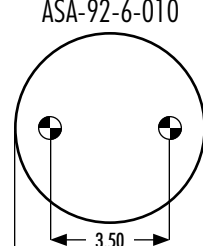
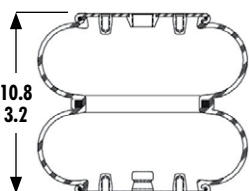
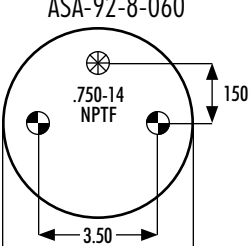
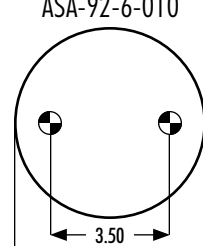
BELLOWS NUMBER	SIDE VIEW WITH EXTENDED AND COMPRESSED HEIGHT	UPPER MOUNTING VIEW	LOWER MOUNTING VIEW	MANUFACTURER NUMBERS
578-92-3-202	2B9-201 	ASA-92-8-016 	ASA-92-6-010 	AUTOMANN ABSP2B12R-6935 CONTI 64515 FD 200-19 499 DAYTON 354-6902 FIRESTONE 6935 W013586935 FLEETRITE 289-491 FREIGHTLINER 16-14318-000 GRANNING 4848 HDA PMA86-6902B HENDRICKSON B-2630 INT'L/NAVISTAR 55478C1 LOAD GUARD SC2010 MASA 227004001 R&S TRUCK & BODY 1027505 RIDEWELL S-1728-C SAUR AXLES P50-733A (LIFT) SPRINGRIDE 289-493 SUSPENSIONS INC. 200042 TAURUS AS218-6902 TRIANGLE 4310 4499 TRP AS69350
578-92-3-202	2B9-206 	ASA-92-8-040 	ASA-92-6-010 	AUTOMANN ABSP2B12R-6905 CONTI 64510 FD 200-19 315 DAYTON 354-6905 E-Z RIDE 8030120 FIRESTONE 6905 W013586905 HENDRICKSON 45843-1 B-3518 B-5270 INT'L/NAVISTAR 1685175C1 LOAD GUARD SC2071 RIDEWELL 1003586905C S-2845-C TAURUS AS218-6905 TRIANGLE 4315 TRP AS69050 WATSON & CHALIN AS-0020
578-92-3-202	2B9-210 	ASA-92-8-040 	ASA-92-6-010 	AUTOMANN ABSP2B12R-6908 CONTI 64511 FD 200-19 362 FIRESTONE 6908 W013586908 TRIANGLE 4362 TRP AS69080 WATSON & CHALIN AS-0035
578-92-3-202	2B9-216 	ASA-92-8-060 	ASA-92-6-010 	DINA AZ-8127-19 PREVOST 63-0174 TRAILERS DE MONTERREY 73312B

- Bolt or Stud – 1/2-13 or 1/2-20
- ⊗ Air Fitting – 1/4 NPTF
- ⊙ Stud – 3/4-10
- ⊕ Tapped Hole on Top Retainers – 3/8-16, on Pistons – 1/2-13
- ⊗ Air Fitting – 1/2 NPTF or 3/8 NPTF
- ⊙ Combination Stud Air Fitting: Stud – 3/4-16, Air Fitting – 1/4 NPTF

AIR SPRING BELLOWS

AIR SPRING BELLOWS

BELLOWS NUMBER	SIDE VIEW WITH EXTENDED AND COMPRESSED HEIGHT	UPPER MOUNTING VIEW	LOWER MOUNTING VIEW	MANUFACTURER NUMBERS
578-92-3-202	2B9-225 	ASA-92-8-117 	ASA-92-6-004 	FIRESTONE 6928 W013586928 TTX 1999408
578-92-3-202	2B9-230 	ASA-92-8-113 	ASA-92-6-044 	AUTOMANN ABSP2B12R-6940 CONTI 64513 FD 200-19 450 FIRESTONE 6940 W013586940 TRIANGLE 4450 TRP AS69400
578-92-3-202	2B9-240 	ASB-92-9-151 	ASB-92-9-151 	FIRESTONE 7119 W013587119 MCI 12C-1-36 PREVOST 63-0166
578-92-3-202	2B9-244 	ASA-92-8-172 	ASA-92-6-044 	
578-92-3-202	2B9-245 	ASA-92-8-113 	ASA-92-6-108 	AUTOMANN ABSP2B12R-7788 CONTI 64519 FD 200-19 510 FIRESTONE 7788 W013587788 TRIANGLE 4510 WATSON & CHALIN AS-0088

- Bolt or Stud – 1/2-13 or 1/2-20
- ⊗ Air Fitting – 1/4 NPTF
- ⊙ Stud – 3/4-10
- ⊕ Tapped Hole on Top Retainers – 3/8-16, on Pistons – 1/2-13
- ⊗ Air Fitting – 1/2 NPTF or 3/8 NPTF
- ⊙ Combination Stud Air Fitting: Stud – 3/4-16, Air Fitting – 1/4 NPTF

AIR SPRING BELLOWS

BELLOWS NUMBER	SIDE VIEW WITH EXTENDED AND COMPRESSED HEIGHT	UPPER MOUNTING VIEW	LOWER MOUNTING VIEW	MANUFACTURER NUMBERS
578-92-3-206	2B9-218 	ASA-92-8-113 	ASA-92-6-010 	AUTOMANN ABSP2B12RA-6927 CONTI 64553 FD 200-25 453 FIRESTONE 6927 W013586927 INT'L/NAVISTAR 1685176C1 LOAD GUARD SC2072
578-92-3-206	2B9-250 	ASA-92-8-040 	ASA-92-6-010 	AUTOMANN ABSP2B12RA-6943 CONTI 64549 FD 200-25 426 FIRESTONE 6943 W013586943 LOAD GUARD SC2122 NEWAY 905-57-237
578-92-3-206	2B9-251 	ASA-92-8-040 	ASA-92-6-010 	AUTOMANN ABSP2B12RA-6948 CONTI 64552 FD 200-25 429 FIRESTONE 6948 W013586948 LOAD GUARD SC2123
578-92-3-206	2B9-252 	ASA-92-8-172 	ASA-92-6-044 	AUTOMANN ABSP2B12RA-6944 CONTI 64512 64554 FD 200-19 448 FD 200-25 454 FIRESTONE 6944 W013586944 HISTEER 10302
578-92-3-206	2B9-253 	ASA-92-8-040 	ASA-92-6-010 	AUTOMANN ABSP2B12RA-6945 CONTI 64550 FD 200-25 427 FIRESTONE 6945 W013586945 LOAD GUARD SC2125

- Bolt or Stud – 1/2-13 or 1/2-20
- ⊗ Air Fitting – 1/4 NPTF
- ⊙ Stud – 3/4-10
- ⊕ Tapped Hole on Top Retainers – 3/8-16, on Pistons – 1/2-13
- ⊗ Air Fitting – 1/2 NPTF or 3/8 NPTF
- ⊙ Combination Stud Air Fitting: Stud – 3/4-16, Air Fitting – 1/4 NPTF

AIR SPRING BELLOWS

AIR SPRING BELLOWS

BELLOWS NUMBER	SIDE VIEW WITH EXTENDED AND COMPRESSED HEIGHT	UPPER MOUNTING VIEW	LOWER MOUNTING VIEW	MANUFACTURER NUMBERS
578-92-3-206	2B9-254 	ASA-92-8-172 	ASA-92-6-010 	AUTOMANN RIDEWELL ABSP2B12RA-6946 1003586946C CONTI SUSPENSIONS 64555 FD 200-25 463 200180 FIRESTONE TRIANGLE 6946 W013586946 4463 LOAD GUARD TRP SC2126 AS69460
578-92-3-206	2B9-255 	ASA-92-8-016 	ASA-92-6-010 	AUTOMANN HENDRICKSON ABSP2B12RA-6947 B-8701 CONTI LOAD 64551 FD 200-25 428 GUARD DAYTON 354-6947 SC2127 FIRESTONE RIDEWELL 6947 W013586947 1003586947C TRIANGLE TRP 4428 AS69470
578-92-3-206	2B9-265 	ASA-92-8-270 	ASA-92-6-044 	AUTOMANN ABSP2B12R-6941 CONTI 64512 FD 200-19 448 FIRESTONE W013586941 TRP AS69410
578-92-3-206	2B9-270 	ASA-92-8-298 	ASA-92-6-010 	RIDEWELL 1002809270G
578-92-3-208	2B9-266 	ASA-92-8-292 	ASA-92-6-044 	CONTI TRIANGLE 64554 FD 200-25 454 4454 FIRESTONE TRP W013586944 AS69440 HISTEER 10307

- Bolt or Stud – 1/2-13 or 1/2-20
- ⊗ Air Fitting – 1/4 NPTF
- ⊙ Stud – 3/4-10
- ⊕ Tapped Hole on Top Retainers – 3/8-16, on Pistons – 1/2-13
- ⊗ Air Fitting – 1/2 NPTF or 3/8 NPTF
- ⊙ Combination Stud Air Fitting: Stud – 3/4-16, Air Fitting – 1/4 NPTF

AIR SPRING BELLOWS

BELLOWS NUMBER	SIDE VIEW WITH EXTENDED AND COMPRESSED HEIGHT	UPPER MOUNTING VIEW	LOWER MOUNTING VIEW	MANUFACTURER NUMBERS
578-92-3-208	2B9-607 	ASA-92-8-270 	ASA-92-6-010 	
578-92-3-211	2B9-229 	ASA-92-8-113 	ASA-92-6-077 	AUTOMANN SPRINGRIDE ABSP2B12R-6897 2B9-494 CONTI TRIANGLE 64517 FD 200-19 505 4505 FIRESTONE TRP 6897 W013586897 AS68860 FLEETRITE WATSON & CHALIN 2B9-490 AS68970 AS-0058
578-92-3-211	2B9-239 	ASA-92-8-016 	ASA-92-010 	AUTOMANN TRP ABSP2B12R-6902 AS69020 CONTI WATSON & CHALIN 64509 FD 200-19 310 AS-0002 FIRESTONE 6902 W013586902 RIDEWELL 1003586902C
578-92-3-211	2B9-246 	ASA-92-8-172 	ASA-92-6-108 	AUTOMANN TRIANGLE ABSP2B12R-6932 4452 CONTI TRP 64514 FD 200-19 452 AS69320 FIRESTONE 6932 W013586932 RIDEWELL 1003586932C
578-92-3-211	2B9-280 	ASA-92-8-172 	ASA-92-6-044 	CONTI TRIANGLE 64512 FD 200-19 448 4428 FIRESTONE TRP 6941 W013586941 AS69410 HISTEER 10302

- Bolt or Stud – 1/2-13 or 1/2-20
- ⊗ Air Fitting – 1/4 NPTF
- ⊙ Stud – 3/4-10
- ⊕ Tapped Hole on Top Retainers – 3/8-16, on Pistons – 1/2-13
- ⊗ Air Fitting – 1/2 NPTF or 3/8 NPTF
- ⊙ Combination Stud Air Fitting: Stud – 3/4-16, Air Fitting – 1/4 NPTF

AIR SPRING BELLOWS

AIR SPRING BELLOWS

BELLOWS NUMBER	SIDE VIEW WITH EXTENDED AND COMPRESSED HEIGHT	UPPER MOUNTING VIEW	LOWER MOUNTING VIEW	MANUFACTURER NUMBERS
578-92-3-211	2B9-288 	ASA-92-8-016 	ASA-92-6-010 	AUTOMANN ABSP2B12R-6926 CONTI 64516 FD 200-19 504 FIRESTONE 6926 W013586926 TRP AS69260
578-92-3-211	2B9-296 	ASA-92-8-113 	ASA-92-6-125 	
578-92-3-211	2B9-606 	ASA-92-8-040 	ASA-92-6-010 	
578-92-3-211	2B9-611 	ASA-92-8-270 	ASA-92-6-134 	
578-92-3-211	2B9-614 	ASA-92-8-270 	ASA-92-6-134 	

- Bolt or Stud – 1/2-13 or 1/2-20
- ⊗ Air Fitting – 1/4 NPTF
- ⊙ Stud – 3/4-10
- ⊕ Tapped Hole on Top Retainers – 3/8-16, on Pistons – 1/2-13
- ⊗ Air Fitting – 1/2 NPTF or 3/8 NPTF
- ⊙ Combination Stud Air Fitting: Stud – 3/4-16, Air Fitting – 1/4 NPTF

AIR SPRING BELLOWS

BELLOWS NUMBER	SIDE VIEW WITH EXTENDED AND COMPRESSED HEIGHT	UPPER MOUNTING VIEW	LOWER MOUNTING VIEW	MANUFACTURER NUMBERS
578-92-3-217	2B9-495 	ASA-92-8-113 	ASA-92-6-010 	AUTOMANN ABSP2B12R-7897 FIRESTONE W01-358-7897 HENDRICKSON S23114
578-92-3-250	2B10-226 	ASA-92-8-113 	ASA-92-6-010 	AUTOMANN ABSP2B12R-7795 CONTI 67705 FD 200-19 713 FIRESTONE 7795 W013587795 HENDRICKSON B-14486
578-92-3-309	2B12-300 	ASA-92-8-003 	ASA-92-6-001 	AUTOMANN ABSP2B22R-7424 CONTI 64283 FD 330-22 327 DAYTON 354-7424 FIRESTONE 7424 W013587424 HDA PMABG-7424B INT'L/NAVISTAR 554785C1 LOAD GUARD SC2024
578-92-3-309	2B12-304 	ASA-92-8-005 	ASA-92-6-006 	AUTOMANN ABSP2B22R-7344 CONTI 64501 FD 330-22 500 FIRESTONE 7344 W013587344

- Bolt or Stud – 1/2-13 or 1/2-20
- ⊗ Air Fitting – 1/4 NPTF
- ⊙ Stud – 3/4-10
- ⊕ Tapped Hole on Top Retainers – 3/8-16, on Pistons – 1/2-13
- ⊗ Air Fitting – 1/2 NPTF or 3/8 NPTF
- ⊙ Combination Stud Air Fitting: Stud – 3/4-16, Air Fitting – 1/4 NPTF

AIR SPRING BELLOWS

AIR SPRING BELLOWS

BELLOWS NUMBER	SIDE VIEW WITH EXTENDED AND COMPRESSED HEIGHT	UPPER MOUNTING VIEW	LOWER MOUNTING VIEW	MANUFACTURER NUMBERS
578-92-3-309	2B12-307 	ASA-92-8-017 	ASA-92-6-002 	AUTOMANN ABSP2B22R-7403 CONTI 64488 FD 330-22 318 DAYTON 354-7403 FIRESTONE 7403 W013587403 GRANNING 2725 HDA PMABG-7403B HENDRICKSON B-1159 B-2883 INT'L/NAVISTAR 554787C1 R&S TRUCK & BODY 1040201 1090201 RIDEWELL S-4302-C SUSPENSIONS INC. 200448 TRIANGLE 4318 TRP AS74030 WATSON & CHALIN AS-0007
578-92-3-309	2B12-309 	ASA-92-8-002 	ASA-92-6-002 	AUTOMANN ABSP2B22R-7400 CONTI 64270 FD 330-22 313 DAYTON 354-7400 FAB TEK 40080 FIRESTONE 7400 W013587400 FREIGHTLINER 16-10769-000 GMC 693230 GRANNING 2726 HDA PMABG-7400B HENDRICK-SON C-1013 INT'L/NAVISTAR 554788C1 LOAD GUARD SC2020 MASA 227002002 NEWAY 905-57-016 TC-144-4 R&S TRUCK & BODY 1027519 RIDEWELL 1003587400C S-788-C TAURUS AS214-7400 TRIANGLE 4313 TRP AS74000 WATSON & CHALIN AS-0003
578-92-3-309	2B12-313 	ASA-92-8-004 	ASA-92-6-004 	AUTOMANN ABSP2B22R-7405 CONTI 64494 FD 330-22 364 DAYTON 354-7405 FIRESTONE 7405 W013587405 HUTCHENS IND. 10384-01 INT'L/NAVISTAR 1685177C1 LOAD GUARD SC2073 SUSPENSIONS INC. 200981 TAURUS AS214-7405 TRIANGLE 4364 TRP AS74050

- Bolt or Stud – 1/2-13 or 1/2-20
- ⊗ Air Fitting – 1/4 NPTF
- ⊙ Stud – 3/4-10
- ⊕ Tapped Hole on Top Retainers – 3/8-16, on Pistons – 1/2-13
- ⊗ Air Fitting – 1/2 NPTF or 3/8 NPTF
- ⊙ Combination Stud Air Fitting: Stud – 3/4-16, Air Fitting – 1/4 NPTF

AIR SPRING BELLOWS

BELLOWS NUMBER	SIDE VIEW WITH EXTENDED AND COMPRESSED HEIGHT	UPPER MOUNTING VIEW	LOWER MOUNTING VIEW	MANUFACTURER NUMBERS
578-92-3-309	2B12-318 	ASA-92-8-006 	ASA-92-6-002 	FIRESTONE 7185 W013587185
578-92-3-309	2B12-319 	ASA-92-8-005 	ASA-92-6-004 	AUTOMANN ABSP2B22R-7409 CONTI 64497 FD 330-22 367 DAYTON 354-7409 FIRESTONE 7409 W013587409 LINT'L/NAVISTAR 1685178C1 OAD GUARD SC2074 TAURUS AS214-7409 TRIANGLE 4367
578-92-3-309	2B12-320 	ASA-92-8-003 	ASA-92-6-004 	AUTOMANN ABSP2B22R-7401 ABSP2B22R-7437 CONTI 64489 FD 330-22 334 DAYTON 354-7437 FIRESTONE 7401 7437 W013587401 W013587437 GMC 2076095 711954 HDA PMABG-7401B INT'L/NAVISTAR 554789C1 LOAD GUARD SC2025 NEWAY 905-57-015 TC-144-3A RIDEWELL 1003587437C S-3363-C TRIANGLE 4334 4337 VOLVO 2076095 WATSON & CHALIN AS-0014
578-92-3-309	2B12-340 	ASB-92-9-153 	ASB-92-8-153 	FIRESTONE 7124 W013587124 MCI 12C-3-52 PREVOST 63-0185

- Bolt or Stud – 1/2-13 or 1/2-20
- ⊗ Air Fitting – 1/4 NPTF
- ⊙ Stud – 3/4-10
- ⊕ Tapped Hole on Top Retainers – 3/8-16, on Pistons – 1/2-13
- ⊗ Air Fitting – 1/2 NPTF or 3/8 NPTF
- ⊙ Combination Stud Air Fitting: Stud – 3/4-16, Air Fitting – 1/4 NPTF

AIR SPRING BELLOWS

BELLOWS NUMBER	SIDE VIEW WITH EXTENDED AND COMPRESSED HEIGHT	UPPER MOUNTING VIEW	LOWER MOUNTING VIEW	MANUFACTURER NUMBERS
578-92-3-309	2B12-406 	ASA-92-8-005 	ASA-92-6-002 	AUTOMANN ABS2P2B22R-7410 CONTI 64268 FD 330-22 331 DAYTON 354-7410 FIRESTONE 7410 W013587410 FREIGHTLINER 16-11378-000 INT'L/NAVISTAR 554792C1 LOAD GUARD SC2023 TAURUS AS214-7410 TRIANGLE 4331 TRP AS74100
578-92-3-309	2B12-410 	ASA-92-8-017 	ASA-92-6-004 	AUTOMANN ABS2P2B22R-7404 CONTI 64492 FD 330-22 346 DAYTON 354-7404 FIRESTONE 7404 W013587404 HENDRICKSON B-1345 B-5468 INT'L/NAVISTAR 554793C1 LOAD GUARD SC2022 TAURUS AS214-7404 TRIANGLE 4346
578-92-3-309	2B12-411 	ASA-92-8-088 	ASA-92-6-006 	AUTOMANN ABS2P2B22R-7181 CONTI 64500 FD 330-22 472 DAYTON 354-7181 FIRESTONE 7181 W013587181 FRUEHAUF UAB-5620 UCC-3054-1 INT'L/NAVISTAR 554794C1 LOAD GUARD SC2018 TAURUS AS214-7181 TRIANGLE 4472
578-92-3-309	2B12-412 	ASA-92-8-088 	ASA-92-6-038 	AUTOMANN ABS2P2B22R-7183 CONTI 64499 FD 330-22 471 DAYTON 354-7183 FIRESTONE 7183 W013587183 FRUEHAUF UCA-0112 UCA-0112B INT'L/NAVISTAR 554795C1 LOAD GUARD SC2019 TAURUS AS214-7183 TRIANGLE 4471
578-92-3-309	2B12-424 	ASA-92-8-006 	ASA-92-6-002 	TRAILERS DE MONTERREY 73312A

- Bolt or Stud – 1/2-13 or 1/2-20
- ⊗ Air Fitting – 1/4 NPTF
- ⊙ Stud – 3/4-10
- ⊕ Tapped Hole on Top Retainers – 3/8-16, on Pistons – 1/2-13
- ⊗ Air Fitting – 1/2 NPTF or 3/8 NPTF
- ⊙ Combination Stud Air Fitting: Stud – 3/4-16, Air Fitting – 1/4 NPTF

AIR SPRING BELLOWS

BELLOWS NUMBER	SIDE VIEW WITH EXTENDED AND COMPRESSED HEIGHT	UPPER MOUNTING VIEW	LOWER MOUNTING VIEW	MANUFACTURER NUMBERS
578-92-3-309	2B12-425 	ASA-92-8-002 	ASA-92-6-002 	AUTOMANN ABS2P2B22R-7180 CONTI 64493 FD 330-22 363 E-Z RIDE 8030190 FIRESTONE 7180 W013587180 INT'L/NAVISTAR 1685179C1 LOAD GUARD SC2075 NEWAY 570-07-180 PEERLESS 0550-00001 RIDEWELL 1003587180C S-4538-C TAURUS AS214-7180 TRIANGLE 4363 TRP AS71800
578-92-3-309	2B12-426 	ASA-92-8-003 	ASA-92-6-002 	AUTOMANN ABS2P2B22R-7406 CONTI 64495 FD 330-22 365 DAYTON 354-7406 FIRESTONE 7406 W013587406 INT'L/NAVISTAR 1685180C1 LOAD GUARD SC2076 RIDEWELL 1003587406C S-3159-C TAURUS AS214-7406 TRIANGLE 4365
578-92-3-309	2B12-427 	ASA-92-8-004 	ASA-92-6-002 	AUTOMANN ABS2P2B22R-7429 CONTI 64491 FD 330-22 343 DAYTON 354-7429 FIRESTONE 7429 W013587429 INT'L/NAVISTAR 1685181C1 KWIK-LOC/TODCO CP-5223 LOAD GUARD SC2077 TAURUS AS214-7429 TRIANGLE 4343
578-92-3-309	2B12-429 	ASA-92-8-006 	ASA-92-6-002 	AUTOMANN ABS2P2B22R-7184 CONTI 66300 FD 330-22 780 FIRESTONE 7184 W013587184
578-92-3-309	2B12-432 	ASA-92-8-005 	ASA-92-6-001 	AUTOMANN ABS2P2B22R-7423 CONTI 64498 FD 330-22 368 FIRESTONE 7423 W013587423 INT'L/NAVISTAR 1681750C1 LOAD GUARD SC2101 TRIANGLE 4368 4465

- Bolt or Stud – 1/2-13 or 1/2-20
- ⊗ Air Fitting – 1/4 NPTF
- ⊙ Stud – 3/4-10
- ⊕ Tapped Hole on Top Retainers – 3/8-16, on Pistons – 1/2-13
- ⊗ Air Fitting – 1/2 NPTF or 3/8 NPTF
- ⊙ Combination Stud Air Fitting: Stud – 3/4-16, Air Fitting – 1/4 NPTF

AIR SPRING BELLOWS

AIR SPRING BELLOWS

BELLOWS NUMBER	SIDE VIEW WITH EXTENDED AND COMPRESSED HEIGHT	UPPER MOUNTING VIEW	LOWER MOUNTING VIEW	MANUFACTURER NUMBERS
578-92-3-309	2B12-463 	ASA-92-8-257 	ASA-92-6-002 	AUTOMANN ABSP2B22R-6850 CONTI 64502 FD 330-22 540 FIRESTONE 6850 W013586850 RIDEWELL 1003586850C TRP AS68500
578-92-3-310	2B12-402 	ASA-92-8-005 	ASA-92-6-002 	AUTOMANN ABSP2B22RA-7446 CONTI 64534 FD 330-30 370 DAYTON 354-7446 FIRESTONE 7446 W013587446 HDA PMA86-74468 HENDRICKSON B-3798 INT'L/NAVISTAR 554791C1 LOAD GUARD SC2027 R&S TRUCK & BODY 1082914 SILENT DRIVE AS-7446 TRIANGLE 4370 TRP AS74460 WATSON & CHALIN AS-0005
578-92-3-310	2B12-428 	ASA-92-8-002 	ASA-92-6-002 	AUTOMANN ABSP2B22RA-7473 CONTI 64536 FD 330-30 372 FIRESTONE 7473 W013587473 INT'L/NAVISTAR 1685182C1 LOAD GUARD SC2078 RIDEWELL 1003587473C TRIANGLE 4372
578-92-3-310	2B12-434 	ASA-92-8-017 	ASA-92-6-002 	AUTOMANN ABSP2B22RA-7472 CONTI 64535 FD 330-30 371 FIRESTONE 7472 W013587472 HENDRICKSON 36514-5 B-12514-005 INT'L/NAVISTAR 1681751C1 LOAD GUARD SC2128 SAUR AXLES PB10-784 TRIANGLE 4371 4464
578-92-3-310	2B12-446 	ASA-92-8-002 	ASA-92-6-002 	CONTI 64533 FD 330-30 369 FIRESTONE 7444 W013587444 HENDRICKSON B-9830 TRIANGLE 4369

- Bolt or Stud – 1/2-13 or 1/2-20
- ⊗ Air Fitting – 1/4 NPTF
- ⊙ Stud – 3/4-10
- ⊕ Tapped Hole on Top Retainers – 3/8-16, on Pistons – 1/2-13
- ⊗ Air Fitting – 1/2 NPTF or 3/8 NPTF
- ⊙ Combination Stud Air Fitting: Stud – 3/4-16, Air Fitting – 1/4 NPTF

AIR SPRING BELLOWS

BELLOWS NUMBER	SIDE VIEW WITH EXTENDED AND COMPRESSED HEIGHT	UPPER MOUNTING VIEW	LOWER MOUNTING VIEW	MANUFACTURER NUMBERS
578-92-3-315	2B12-345 	ASA-92-8-005 	ASA-92-6-002 	AUTOMANN ABSP2B22RB-7545 CONTI 64597 FD 331-26 514 FIRESTONE 7545 W013587545 HENDRICKSON 1796 TRIANGLE 4514 WATSON & CHALIN AS-0087-1F
578-92-3-315	2B12-346 	ASA-92-8-005 	ASA-92-6-002 	AUTOMANN ABSP2B22RB-7550 CONTI 64599 FD 331-26-541 FIRESTONE 7550 W013587550 HISTEER 10315 TRIANGLE 4541 TRP AS75500 WATSON & CHALIN AS-0087
578-92-3-315	2B12-416 	ASA-92-8-002 	ASA-92-6-002 	AUTOMANN ABSP2B22RA-7444 CONTI 64533 FD 330-30 369 FIRESTONE 7444 W013587444 HENDRICKSON B-9830 TRIANGLE 4369
578-92-3-315	2B12-440 	ASA-92-8-005 	ASA-92-6-004 	AUTOMANN ABSP2B22RB-7555 CONTI 64284 FD 331-26 480 FIRESTONE 7555 W013587555 HENDRICKSON 20018 REYCO 18813-01 20018-01 TRIANGLE 4480 TRP AS75550
578-92-3-353	2B14-354 	ASA-92-8-028 	ASA-92-6-013 	AUTOMANN ABSP2B34R-7145 CONTI 64548 FD 530-22 374 DAYTON 354-7145 FIRESTONE 7145 W013587145 INT'L/NAVISTAR 554796C1 LOAD GUARD SC2016 MACK TRUCK 57Q1239 RIDEWELL 1003587145C S-4540-C TRIANGLE 4374 TRP AS71450 VOLVO 35203-0005 35203-3204

- Bolt or Stud – 1/2-13 or 1/2-20
- ⊗ Air Fitting – 1/4 NPTF
- ⊙ Stud – 3/4-10
- ⊕ Tapped Hole on Top Retainers – 3/8-16, on Pistons – 1/2-13
- ⊗ Air Fitting – 1/2 NPTF or 3/8 NPTF
- ⊙ Combination Stud Air Fitting: Stud – 3/4-16, Air Fitting – 1/4 NPTF

AIR SPRING BELLOWS

AIR SPRING BELLOWS

BELLOWS NUMBER	SIDE VIEW WITH EXTENDED AND COMPRESSED HEIGHT	UPPER MOUNTING VIEW	LOWER MOUNTING VIEW	MANUFACTURER NUMBERS	
578-92-3-353	2B14-355 	ASA-92-8-028 	ASA-92-6-013 	AMERICAN CARRIER 8003005 AUTOMANN ABSP2B34R-7146 CONTI 64546 FD 530-22 342 DAYTON 354-7146 FIRESTONE 7146 FIRESTONE W013587146	INT'L/NAVISTAR 554797C1 LOAD GUARD SC2017 NEWAY 905-57-039 AR-1520 RIDEWELL 1003587146C TRIANGLE 4342
578-92-3-353	2B14-356 	ASA-92-8-028 	ASA-92-6-013 	AUTOMANN ABSP2B34R-7136 CONTI 64545 FD 530-22 321 DAYTON 354-7136 FIRESTONE 7136 W013587136 GRANNING 1626 HDA PMA8G-7136B HENDRICKSON B-1080	INT'L/NAVISTAR 554798C1 LOAD GUARD SC2014 R&S TRUCK & BODY 1027556 RIDEWELL 1003587136C TRIANGLE 4321 WATSON & CHALIN AS-0004
578-92-3-353	2B14-359 	ASA-92-8-031 	ASA-92-6-015 	AUTOMANN ABSP2B34R-7140 CONTI 64544 FD 530-22 316 DAYTON 354-7140 FIRESTONE 7140 W013587140 GRANNING 1015 HDA PMA8G-7140B HENDRICKSON B-3184	INT'L/NAVISTAR 554799C1 LOAD GUARD SC2015 R&S TRUCK & BODY 1090214 RIDEWELL 1003587140C TRIANGLE 4316 TRP AS71400 WATSON & CHALIN AS-0008
578-92-3-353	2B14-360 	ASA-92-8-031 	ASA-92-6-015 	AUTOMANN ABSP2B34R-7135 CONTI 64543 FD 530-22 311 DAYTON 354-7135 FIRESTONE 7135 W013587135 HENDRICKSON B-12514-014 INT'L/NAVISTAR 554800C1 LOAD GUARD SC2013	NEWAY 905-57-001 PEZZANI AR-21-A RIDEWELL 1003587135C S-1326-C TRIANGLE 4311 TRP AS71350 TRUCKSTELL 63641 63644
578-92-3-353	2B14-366 	ASA-92-8-100 	ASA-92-6-015 	AUTOMANN ABSP2B34RB-6803 CONTI 64589 FD 530-30 449 DAYTON 354-6803 FIRESTONE 6803 W013586803 HENDRICKSON B-6412	LOAD GUARD SC2129 TRIANGLE 4449 TRP AS68030

- Bolt or Stud – 1/2-13 or 1/2-20
- ⊗ Air Fitting – 1/4 NPTF
- ⊙ Stud – 3/4-10
- ⊕ Tapped Hole on Top Retainers – 3/8-16, on Pistons – 1/2-13
- ⊗ Air Fitting – 1/2 NPTF or 3/8 NPTF
- ⊙ Combination Stud Air Fitting: Stud – 3/4-16, Air Fitting – 1/4 NPTF

AIR SPRING BELLOWS

BELLOWS NUMBER	SIDE VIEW WITH EXTENDED AND COMPRESSED HEIGHT	UPPER MOUNTING VIEW	LOWER MOUNTING VIEW	MANUFACTURER NUMBERS	
578-92-3-353	2B14-367 	ASA-92-8-049 	ASA-92-6-043 	AUTOMANN ABSP2B34R-7123 CONTI 64547 FD 530-22 345 DAYTON 354-7123 FIRESTONE 7123 7133 W013587123 W013587133	INT'L/NAVISTAR 1685184C1 KWIK-LOK/TODCO 53671 LOAD GUARD SC2080 TRIANGLE 4345
578-92-3-353	2B14-473 	ASA-92-8-046 	ASA-92-6-014 		
578-92-3-356	2B14-362 	ASA-92-8-028 	ASA-92-6-013 	FIRESTONE 6800	
578-92-3-356	2B14-363 	ASA-92-8-030 	ASA-92-6-013 		
578-92-3-356	2B14-365 	ASA-92-8-046 	ASA-92-6-014 	AUTOMANN ABSP2B34RB-6801 CONTI 64590 FD 530-30 451 DAYTON 354-6801 E-Z RIDE 8030160 FIRESTONE 6801 W013586801 HENDRICKSON B-2734	INT'L/NAVISTAR 1685183C1 LOAD GUARD SC2079 RIDEWELL 1003586801C TRIANGLE 4451 TRP AS68010 WATSON & CHALIN AS-0021

- Bolt or Stud – 1/2-13 or 1/2-20
- ⊗ Air Fitting – 1/4 NPTF
- ⊙ Stud – 3/4-10
- ⊕ Tapped Hole on Top Retainers – 3/8-16, on Pistons – 1/2-13
- ⊗ Air Fitting – 1/2 NPTF or 3/8 NPTF
- ⊙ Combination Stud Air Fitting: Stud – 3/4-16, Air Fitting – 1/4 NPTF

AIR SPRING BELLOWS

AIR SPRING BELLOWS

BELLOWS NUMBER	SIDE VIEW WITH EXTENDED AND COMPRESSED HEIGHT	UPPER MOUNTING VIEW	LOWER MOUNTING VIEW	MANUFACTURER NUMBERS
578-92-3-356	2B14-383 	ASA-92-8-174 	ASA-92-6-118 	AUTOMANN ABSP2B34RC-7557 CONTI 64604 FD 530-35 530 FIRESTONE 7557 W013587557 HISTEER 10316 REYCO 19983-01 TRIANGLE 4530 TRP AS75570 WATSON & CHALIN AS-0089
578-92-3-356	2B14-462 	ASA-92-8-030 	ASA-92-6-013 	AUTOMANN ABSP2B34RB-6805 CONTI 64593 FD 530-30 532 FIRESTONE 6805 W013586805 RIDEWELL 1003586805C TRP AS68050
578-92-3-356	2B14-470 	ASA-92-8-031 	ASA-92-6-015 	AUTOMANN ABSP2B34RC-7782 CONTI 64606 FD 530-35 544 FIRESTONE 7782 W013587782 TRIANGLE 4544 TRP AS77820 WATSON & CHALIN AS-0032
578-92-3-356	2B14-476 	ASA-92-8-352 	ASA-92-6-016 	AUTOMANN ABSP2B34RC-6799 CONTI 64605 FD 530-35 543 FIRESTONE 6799 W013586799 NEWAY 905-57-023 TRIANGLE 4543 TRP AS67990 WATSON & CHALIN AS-0034
578-92-3-356	2B14-479 	ASA-92-8-030 	ASA-92-6-013 	

- Bolt or Stud – 1/2-13 or 1/2-20
- ⊗ Air Fitting – 1/4 NPTF
- ⊙ Stud – 3/4-10
- ⊕ Tapped Hole on Top Retainers – 3/8-16, on Pistons – 1/2-13
- ⊗ Air Fitting – 1/2 NPTF or 3/8 NPTF
- ⊙ Combination Stud Air Fitting: Stud – 3/4-16, Air Fitting – 1/4 NPTF

AIR SPRING BELLOWS

BELLOWS NUMBER	SIDE VIEW WITH EXTENDED AND COMPRESSED HEIGHT	UPPER MOUNTING VIEW	LOWER MOUNTING VIEW	MANUFACTURER NUMBERS
578-93-3-100	3B12-300 	ASA-92-8-017 	ASA-92-6-002 	AUTOMANN ABSP3B22R-8008 ABSP3B22R-8025 CONTI 64562 FT 330-29 431 DAYTON 354-8008 FIRESTONE 8008 8025 W013588008 W013588025 HENDRICKSON 8-11637 LOAD GUARD SC2130 RIDEWELL 1003588008C TRIANGLE 4431 4469 TRP AS80080 WATSON & CHALIN AS-0019
578-93-3-100	3B12-301 	ASA-92-8-002 	ASA-92-6-002 	AUTOMANN ABSP3B22R-8010 ABSP3B22R-8030 CONTI 64563 FT 330-29 432 FIRESTONE 8010 8030 W013588010 W013588030 LOAD GUARD SC2119 RIDEWELL 1003588010C 1003588030C S-5844-C TRIANGLE 4432 TRP AS80100
578-93-3-100	3B12-303 	ASA-92-8-005 	ASA-92-6-002 	AUTOMANN ABSP3B22R-8018 CONTI 64285 FT 330-29 434 FIRESTONE 8018 W013588018 HISTEER 10303 LOAD GUARD SC2131 TRIANGLE 4434 TRP AS80180 WATSON & CHALIN AS-0075
578-93-3-100	3B12-304 	ASA-92-8-002 	ASA-92-6-000 	AUTOMANN ABSP3B22R-8006 CONTI 64568 FT 330-29 503 FIRESTONE 8006 W013588006 LOAD GUARD SC2132 SUSPENSIONS INC. 200620 TRIANGLE 4430 4503 TRP ASP1710
578-93-3-100	3B12-305 	ASA-92-8-006 	ASA-92-6-002 	

- Bolt or Stud – 1/2-13 or 1/2-20
- ⊗ Air Fitting – 1/4 NPTF
- ⊙ Stud – 3/4-10
- ⊕ Tapped Hole on Top Retainers – 3/8-16, on Pistons – 1/2-13
- ⊗ Air Fitting – 1/2 NPTF or 3/8 NPTF
- ⊙ Combination Stud Air Fitting: Stud – 3/4-16, Air Fitting – 1/4 NPTF

AIR SPRING BELLOWS

AIR SPRING BELLOWS

BELLOWS NUMBER	SIDE VIEW WITH EXTENDED AND COMPRESSED HEIGHT	UPPER MOUNTING VIEW	LOWER MOUNTING VIEW	MANUFACTURER NUMBERS
578-93-3-100	3B12-310 	ASA-92-8-005 	ASA-92-6-002 	AUTOMANN ABSP3B22R-8027 CONTI 64565 FT 330-29 466 FIRESTONE 8027 W013588027 SILENT DRIVE AS-8025 AS-8027 SUSPENSIONS INC. 200117 TRIANGLE 4466 TRP AS80270
578-93-3-100	3B12-312 	ASA-92-8-005 	ASA-92-6-035 	AUTOMANN ABSP3B22R-8033 CONTI 64571 FT 330-29 525 FIRESTONE 8033 W013588033 HENDRICKSON B-14487 LOAD GUARD SC2784 TRIANGLE 4508 4525 TRP AS80330
578-93-3-100	3B12-315 	ASA-92-8-017 	ASA-92-6-111 	CONTI 64573 FT 330-29 547 AUTOMANN ABSP3B22R-7996 TRIANGLE 4547 TRP AS79960
578-93-3-100	3B12-319 	ASA-92-8-017 	ASA-92-6-002 	AUTOMANN ABSP3B22R-8032 CONTI 64560 FT 330-29 413 FIRESTONE 8032 W013588032 HENDRICKSON B-12405 S-12405 TRIANGLE 4413 TRP AS80320 WATSON & CHALIN AS-0048
578-93-3-100	3B12-324 	ASA-92-8-159 	ASA-92-6-002 	WATSON & CHALIN AS-0048-26

- Bolt or Stud – 1/2-13 or 1/2-20
- ⊗ Air Fitting – 1/4 NPTF
- ⊙ Stud – 3/4-10
- ⊕ Tapped Hole on Top Retainers – 3/8-16, on Pistons – 1/2-13
- ⊗ Air Fitting – 1/2 NPTF or 3/8 NPTF
- ⊙ Combination Stud Air Fitting: Stud – 3/4-16, Air Fitting – 1/4 NPTF

AIR SPRING BELLOWS

BELLOWS NUMBER	SIDE VIEW WITH EXTENDED AND COMPRESSED HEIGHT	UPPER MOUNTING VIEW	LOWER MOUNTING VIEW	MANUFACTURER NUMBERS
578-93-3-100	3B12-328 	ASA-92-8-017 	ASA-92-6-111 	AUTOMANN ABSP3B22R-7994 CONTI 64572 FT 330-29546 FIRESTONE 7994 W013587994 TRIANGLE 4546 WATSON & CHALIN AS-0019-1F
578-93-3-100	3B12-329 	ASA-92-8-159 	ASA-92-6-111 	AUTOMANN ABSP3B22R-7995 CONTI 64573 FT 330-29 546 FIRESTONE 7990 W013587990 TRIANGLE 4547 WATSON & CHALIN AS-0048-1F
578-93-3-100	3B12-335 	ASA-92-8-005 	ASA-92-6-111 	AUTOMANN ABSP3B22R-7996 CONTI 64570 FT 330-29 520 FIRESTONE 7996 W013587996 GRANNING 8221 TRIANGLE 4520 TRP AS79960
578-93-3-100	3B12-338 	ASA-92-8-331 	ASA-92-6-002 	
578-93-3-100	3B12-342 	ASA-92-8-431 	ASA-92-6-002 	WATSON & CHALIN AS-0048-3G

- Bolt or Stud – 1/2-13 or 1/2-20
- ⊗ Air Fitting – 1/4 NPTF
- ⊙ Stud – 3/4-10
- ⊕ Tapped Hole on Top Retainers – 3/8-16, on Pistons – 1/2-13
- ⊗ Air Fitting – 1/2 NPTF or 3/8 NPTF
- ⊙ Combination Stud Air Fitting: Stud – 3/4-16, Air Fitting – 1/4 NPTF

AIR SPRING BELLOWS

AIR SPRING BELLOWS

BELLOWS NUMBER	SIDE VIEW WITH EXTENDED AND COMPRESSED HEIGHT	UPPER MOUNTING VIEW	LOWER MOUNTING VIEW	MANUFACTURER NUMBERS
578-93-3-103	3B12-322 	ASA-92-8-230 	ASA-92-6-110 	AUTOMANN ABSP3B22R-8042 FIRESTONE 8042 W013588042 HENDRICKSON 1015 NEWAY 905-57-236
578-93-3-103	3B12-323 	ASA-92-8-367 	ASA-92-6-110 	AUTOMANN ABSP3B22R-8043 FIRESTONE 8043 W013588043 HENDRICKSON S-14795
578-93-3-103	3B12-325 	ASA-92-8-363 	ASA-92-6-106 	FIRESTONE 8048 W013588048
578-93-3-103	3B12-326 	ASA-92-8-364 	ASA-92-6-106 	FIRESTONE 8047 W013588047
578-93-3-103	3B12-347 	ASA-92-8-367 	ASA-92-6-121 	

- Bolt or Stud – 1/2-13 or 1/2-20
- ⊗ Air Fitting – 1/4 NPTF
- ⊙ Stud – 3/4-10
- ⊕ Tapped Hole on Top Retainers – 3/8-16, on Pistons – 1/2-13
- ⊗ Air Fitting – 1/2 NPTF or 3/8 NPTF
- ⊙ Combination Stud Air Fitting: Stud – 3/4-16, Air Fitting – 1/4 NPTF

AIR SPRING BELLOWS

BELLOWS NUMBER	SIDE VIEW WITH EXTENDED AND COMPRESSED HEIGHT	UPPER MOUNTING VIEW	LOWER MOUNTING VIEW	MANUFACTURER NUMBERS
578-93-3-104	3B12-337 	ASA-92-8-406 	ASA-92-6-110 	
578-93-3-105	3B12-415 	ASA-92-8-017 	ASA-92-6-002 	AUTOMANN ABSP3B22R-8038 CONTI 66522 FT 330-29 554 FIRESTONE 8038 W013588038 HISTEER 10313
578-93-3-105	3B12-416 	ASA-92-8-005 	ASA-92-6-002 	FIRESTONE 8039 W013588039 HISTEER 10303
578-93-3-350	3B14-351 	ASA-92-8-028 	ASA-92-6-013 	
578-93-3-350	3B14-354 	ASA-92-8-028 	ASA-92-6-013 	AUTOMANN ABSP3B32R-7808 CONTI 64506 FT 530-32 336 E-Z RIDE 8030170 FIRESTONE 7808 W013587808 INT'L/NAVISTAR 554801C1 LOAD GUARD SC2031 PEERLESS 0550-00030 RIDEWELL 1003587808C S-4830-C TRIANGLE 4336 TRP AS78080 TRUCKSTELL 63640

- Bolt or Stud – 1/2-13 or 1/2-20
- ⊗ Air Fitting – 1/4 NPTF
- ⊙ Stud – 3/4-10
- ⊕ Tapped Hole on Top Retainers – 3/8-16, on Pistons – 1/2-13
- ⊗ Air Fitting – 1/2 NPTF or 3/8 NPTF
- ⊙ Combination Stud Air Fitting: Stud – 3/4-16, Air Fitting – 1/4 NPTF

AIR SPRING BELLOWS

AIR SPRING BELLOWS

BELLOWS NUMBER	SIDE VIEW WITH EXTENDED AND COMPRESSED HEIGHT	UPPER MOUNTING VIEW	LOWER MOUNTING VIEW	MANUFACTURER NUMBERS
578-93-3-350	3B14-356 	ASA-92-8-028 	ASA-92-6-013 	AUTOMANN ABSP3832R-7798 CONTI 64504 FT 530-32 329 DAYTON 354-7798 FIRESTONE 7798 W013587798 GRANNING 1613 HDA PMABG-7798B INT'L/NAVISTAR 554802C1 LOAD GUARD SC2029 TRIANGLE 4329 4436 WATSON & CHALIN AS-0006
578-93-3-350	3B14-359 	ASA-92-8-031 	ASA-92-6-015 	AUTOMANN ABSP3832R-7818 CONTI 64503 FT 530-32 325 DAYTON 354-7818 E-Z RIDE 8030180 FIRESTONE 7816 7818 W013587816 W013587818 GRANNING 1014 1476 HENDRICKSON B-6861 INT'L/NAVISTAR 554803C1 LOAD GUARD SC2032 RIDEWELL 1003587818C 1003587839C S-2685-C TRIANGLE 4325 4437 WATSON & CHALIN AS-0025 AS-0033
578-93-3-350	3B14-360 	ASA-92-8-031 	ASA-92-6-015 	AUTOMANN ABSP3832R-7800 CONTI 64505 FT 530-32 333 DAYTON 354-7800 FIRESTONE 7800 W013587800 GRANNING 4514 HOLLAND HITCH 4514 INT'L/NAVISTAR 554804C1 LOAD GUARD SC2030 RIDEWELL 1003587800C S-1505-C TRIANGLE 4333 4439
578-93-3-350	3B14-361 	ASA-92-8-030 	ASA-92-6-013 	

- Bolt or Stud – 1/2-13 or 1/2-20
- ⊗ Air Fitting – 1/4 NPTF
- ⊙ Stud – 3/4-10
- ⊕ Tapped Hole on Top Retainers – 3/8-16, on Pistons – 1/2-13
- ⊗ Air Fitting – 1/2 NPTF or 3/8 NPTF
- ⊙ Combination Stud Air Fitting: Stud – 3/4-16, Air Fitting – 1/4 NPTF

AIR SPRING BELLOWS

BELLOWS NUMBER	SIDE VIEW WITH EXTENDED AND COMPRESSED HEIGHT	UPPER MOUNTING VIEW	LOWER MOUNTING VIEW	MANUFACTURER NUMBERS
578-93-3-350	3B14-364 	ASA-92-8-100 	ASA-92-6-015 	CONTI 64581 FT 530-35 455 HENDRICKSON B-7100 TRIANGLE 4455
578-93-3-350	3B14-365 	ASA-92-8-100 	ASA-92-6-015 	
578-93-3-350	3B14-367 	ASA-92-8-100 	ASA-92-6-050 	CONTI 64583 FT 530-35 457 DAYTON 354-7847 FIRESTONE 7847 HENDRICKSON B-8874 TRIANGLE 4457
579-91-3-501	1B5-510 	ASC-92-8-109 	ASB-92-6-045 	
579-91-3-532	1B8-564 	ASC-92-8-171 	ASB-92-6-055 	

- Bolt or Stud – 1/2-13 or 1/2-20
- ⊗ Air Fitting – 1/4 NPTF
- ⊙ Stud – 3/4-10
- ⊕ Tapped Hole on Top Retainers – 3/8-16, on Pistons – 1/2-13
- ⊗ Air Fitting – 1/2 NPTF or 3/8 NPTF
- ⊙ Combination Stud Air Fitting: Stud – 3/4-16, Air Fitting – 1/4 NPTF

AIR SPRING BELLOWS

AIR SPRING BELLOWS

BELLOWS NUMBER	SIDE VIEW WITH EXTENDED AND COMPRESSED HEIGHT	UPPER MOUNTING VIEW	LOWER MOUNTING VIEW	MANUFACTURER NUMBERS
579-92-3-510	2B6-530 	ASC-92-8-154 	ASB-92-6-051 	
579-92-3-515	2B6-535 	ASC-92-8-175 	ASA-92-6-052 	CONTI 66094 FD110-15766 LOAD AIR P10-754U
579-92-3-525	2B7-540 	ASA-92-8-114 	ASB-92-6-049 	
579-92-3-525	2B7-541 	ASC-92-8-171 	ASB-92-6-049 	
579-92-3-525	2B7-542 	ASC-92-8-171 	ASB-92-6-058 	

- Bolt or Stud – 1/2-13 or 1/2-20
- ⊗ Air Fitting – 1/4 NPTF
- ⊙ Stud – 3/4-10
- ⊕ Tapped Hole on Top Retainers – 3/8-16, on Pistons – 1/2-13
- ⊗ Air Fitting – 1/2 NPTF or 3/8 NPTF
- ⊙ Combination Stud Air Fitting: Stud – 3/4-16, Air Fitting – 1/4 NPTF

AIR SPRING BELLOWS

BELLOWS NUMBER	SIDE VIEW WITH EXTENDED AND COMPRESSED HEIGHT	UPPER MOUNTING VIEW	LOWER MOUNTING VIEW	MANUFACTURER NUMBERS
579-92-3-526	2B7-548 	ASC-92-8-171 	ASC-92-6-122 	CONTI 67667 FD110-17A775 HENDRICKSON 5079 TRP ASC7750
579-92-3-530	2B8-550 	ASA-92-8-114 	ASB-92-6-049 	AMERICAN CARRIER 8003006 AUTOMANN ABSP2B08RA-7325 CONTI 64601 FD 120-20 509 FIRESTONE 7325 W013587325 MACK TRUCK 227QS32 57QK1113 TRIANGLE 4509 TRP AS73250 WATSON & CHALIN AS-0030

- Bolt or Stud – 1/2-13 or 1/2-20
- ⊗ Air Fitting – 1/4 NPTF
- ⊙ Stud – 3/4-10
- ⊕ Tapped Hole on Top Retainers – 3/8-16, on Pistons – 1/2-13
- ⊗ Air Fitting – 1/2 NPTF or 3/8 NPTF
- ⊙ Combination Stud Air Fitting: Stud – 3/4-16, Air Fitting – 1/4 NPTF

AIR SPRING BELLOWS

AIR SPRING ROLLING LOBES

AIR SPRING ROLLING LOBES

BELLOWS NUMBER	SIDE VIEW WITH EXTENDED AND COMPRESSED HEIGHT	UPPER MOUNTING VIEW	LOWER MOUNTING VIEW	MANUFACTURER NUMBERS
566-16-3-007 PISTON 566-16-7-000 ALUMINUM	1R8-009 	ASC-16-8-003 		
566-16-3-007 PISTON 566-16-7-000 ALUMINUM	1R8-031 	ASC-16-8-004 		
566-16-3-007 PISTON 566-16-7-021 COMPOSITE	1R8-034 	ASC-16-8-004 		FIRESTONE 5710 5730 W013585710 W013585730 FLXIBLE 6-304-156 6-336-175 GMC 10530086 6617550 698634 GMC CONT. 8870484 65008051 LES AUTOBUS 10530086 698934 G5001705 NOVABUS G5001705 G5001706 PREVOST 63-0226
566-16-3-007 OBSOLETE PISTON 566-16-7-021 COMPOSITE	1R8-041 	ASC-16-8-004 		
566-18-3-003 PISTON 566-16-7-009 STEEL	1R9-065 	ASC-16-8-024 		AUTOMANN AB1DK10A-2119 AB1DK10D-8997 CONTI 6 6.5-11 S 027 68108 FIRESTONE 2119 8997 W013582119 W013588997 GRANNING 5112 HENDRICKSON B-2394 NEWAY 905-57-029 905-57-034 RIDEWELL 1003588997C TRIANGLE 8525 WATSON & CHALIN AS-0026

- Bolt or Stud – 1/2-13 or 1/2-20
- ⊗ Air Fitting – 1/4 NPTF
- ⊙ Stud – 3/4-10
- ⊕ Tapped Hole on Top Retainers – 3/8-16, on Pistons – 1/2-13
- ⊗ Air Fitting – 1/2 NPTF or 3/8 NPTF
- ⊙ Combination Stud Air Fitting: Stud – 3/4-16, Air Fitting – 1/4 NPTF

BELLOWS NUMBER	SIDE VIEW WITH EXTENDED AND COMPRESSED HEIGHT	UPPER MOUNTING VIEW	LOWER MOUNTING VIEW	MANUFACTURER NUMBERS
566-18-3-004 PISTON 566-16-7-021 COMPOSITE	1R9-003 	ASC-16-8-004 		AM GENERAL 5973923 AUTOMANN AB1DK10B-5409 CONTI 6 6.5-13 S 056 68136 FIRESTONE 5409 W013585409 W103585435 FLXIBLE 6-336-11 GMC 662743 NEW FLYER 5920815 5973877 5973923 5993113
566-18-3-004 PISTON NOT INCLUDED	1R9-047 	ASC-16-8-004 	USE EXISTING SUPER CUSHION PISTON	FLXIBLE 6-336-166
566-18-3-004 PISTON 566-16-7-021 COMPOSITE	1R9-053 	ASC-16-8-003 		GMC 672755 MCI 12L-4-212 12L-4-8
566-18-3-004 PISTON 566-16-7-000 ALUMINUM	1R9-054 	ASC-16-8-020 		INT'L/ NAVISTAR 2013947C2
566-18-3-004 PISTON 566-16-7-000 ALUMINUM	1R9-056 	ASC-16-8-020 		INT'L/ NAVISTAR 2013948C2

- Bolt or Stud – 1/2-13 or 1/2-20
- ⊗ Air Fitting – 1/4 NPTF
- ⊙ Stud – 3/4-10
- ⊕ Tapped Hole on Top Retainers – 3/8-16, on Pistons – 1/2-13
- ⊗ Air Fitting – 1/2 NPTF or 3/8 NPTF
- ⊙ Combination Stud Air Fitting: Stud – 3/4-16, Air Fitting – 1/4 NPTF

AIR SPRING ROLLING LOBES

AIR SPRING ROLLING LOBES

AIR SPRING ROLLING LOBES

BELLOWS NUMBER	SIDE VIEW WITH EXTENDED AND COMPRESSED HEIGHT	UPPER MOUNTING VIEW	LOWER MOUNTING VIEW	MANUFACTURER NUMBERS
566-18-3-004 PISTON 566-16-7-021 COMPOSITE	1R9-070 	ASC-16-004 		AUTOMANN AB1DK10B-5410 CONTI 6 6.5-13 S 446 68123 FIRESTONE 5410 W013585410 GRANNING 2112 RIDEWELL 1003585410C TRIANGLE 8446 WATSON & CHALIN AS-0029
566-18-3-004 PISTON 566-16-7-021 COMPOSITE	1R9-071 	ASC-16-8-018 		AUTOMANN AB1DK10B-5410
566-18-3-010 PISTON 566-16-7-017 ALUMINUM	1R9-025 OBSOLETE 	ASC-16-8-004 		
566-18-3-010 PISTON 566-16-7-017 ALUMINUM	1R9-038 	ASC-16-8-004 		AUTOMANN AB1DK10B-5406 CONTI 6 6.5-13 S 039 68121 FIRESTONE 5406 W013585406 GMC 2021085 667512A 667512C 716111 GRANNING 1971
566-20-7-038 PISTON 566-20-7-233 COMPOSITE	1R12-419 	ASA-92-8-311 		

- Bolt or Stud – 1/2-13 or 1/2-20
- ⊗ Tapped Hole on Top Retainers – 3/8-16, on Pistons – 1/2-13
- ⊗ Air Fitting – 1/4 NPTF
- ⊗ Air Fitting – 1/2 NPTF or 3/8 NPTF
- ⊙ Stud – 3/4-10
- ⊗ Combination Stud Air Fitting: Stud – 3/4-16, Air Fitting – 1/4 NPTF

BELLOWS NUMBER	SIDE VIEW WITH EXTENDED AND COMPRESSED HEIGHT	UPPER MOUNTING VIEW	LOWER MOUNTING VIEW	MANUFACTURER NUMBERS
566-20-7-038 PISTON 566-20-7-246 STEEL	1R12-423 	ASA-92-8-199 		VOLVO 3180673
566-20-7-076 PISTON 566-20-7-158 COMPOSITE	1R12-421 	ASA-92-8-164 		CONTI 910-14 P 345 64258 FIRESTONE 9010 W013589010 REYCO 12928-01 RIDEWELL 1003589010C TRIANGLE 8345 WATSON & CHALIN AS-0044
566-20-7-076 PISTON 566-20-7-036 ALUMINUM	1R12-422 	ASA-92-8-013 		CONTI 910-12A104 68638 NOVABUS N21361
566-20-7-120 PISTON 566-20-7-223 STEEL	1R12-406 	ASA-92-8-268 		PREVOST 63-0162
566-22-3-006 PISTON 566-20-7-079 STEEL	1R11-018 	ASA-20-8-004 		CONTI 99-14A322 DAYTON 352-9073 352-9415 FIRESTONE 9073 9415 W013589415 HENDRICKSON B-7193 INT'L/NAVISTAR 554761C1 KENWORTH K-102-A K-303-5 LOAD GUARD SC2049 RIDEWELL 1003589073C 1013580708C TAURUS AS103-9073 TRIANGLE 8322

- Bolt or Stud – 1/2-13 or 1/2-20
- ⊗ Tapped Hole on Top Retainers – 3/8-16, on Pistons – 1/2-13
- ⊗ Air Fitting – 1/4 NPTF
- ⊗ Air Fitting – 1/2 NPTF or 3/8 NPTF
- ⊙ Stud – 3/4-10
- ⊗ Combination Stud Air Fitting: Stud – 3/4-16, Air Fitting – 1/4 NPTF

AIR SPRING ROLLING LOBES

AIR SPRING ROLLING LOBES

AIR SPRING ROLLING LOBES

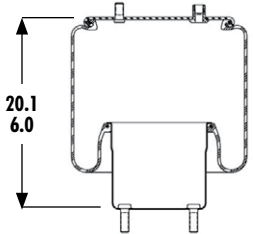
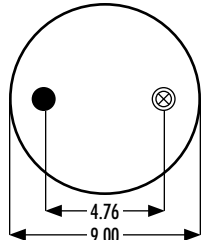
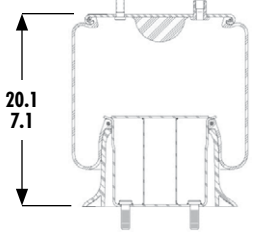
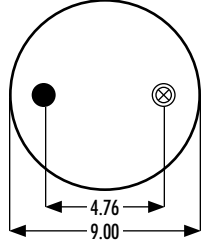
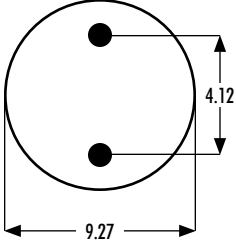
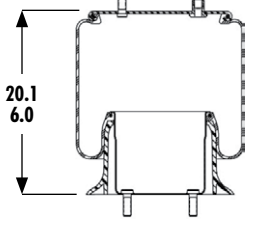
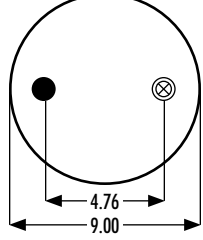
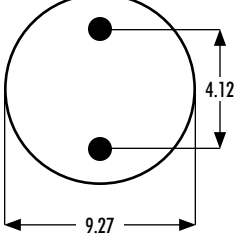
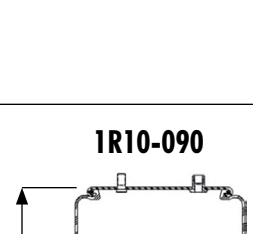
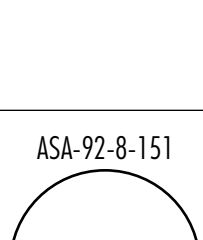
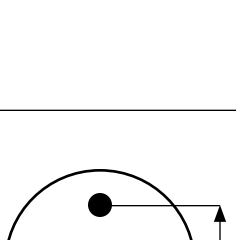
BELLOWS NUMBER	SIDE VIEW WITH EXTENDED AND COMPRESSED HEIGHT	UPPER MOUNTING VIEW	LOWER MOUNTING VIEW	MANUFACTURER NUMBERS
566-22-3-021 PISTON NOT INCLUDED	1R10-085 	ASA-92-8-151 	USE EXISTING SUPER CUSHION PISTON	FIRESTONE 9017 W013589017 FLXIBLE 97-240-153 GMC 661759A 661759C 667302 677302 8875032 61019449 LES AUTOBUS 661759C NOVABUS N15558 PREVOST 63-0044 TMC 661759C
566-22-3-021 PISTON 566-20-7-240 COMPOSITE	1R10-087 	ASA-92-8-152 		BLUEBIRD 990671 FLXIBLE 6-336-212 GMC 61019452 PREVOST 63-0067 63-0158
566-22-3-021 PISTON 566-20-7-240 COMPOSITE	1R10-089 	ASA-92-8-151 		AUTO BUS 10530087 FIRESTONE 9017 9067 9236HR 9386 9436 9610 W013589017 W013589067 W013589236 W013589386 W013589436 W013589610 FLXIBLE 6-304-157 6-336-174 6-841-92 97-240-153 GMC 10530087 661756 684192 684193 6989635 61019450 61020957 NOVABUS N15558 PREVOST 63-0044
566-22-3-021 PISTON 566-20-7-120 COMPOSITE	1R10-090 	ASA-92-8-151 		GMC 10530087 661756 684192 684193 6989635 61019450 61020957 LES AUTOBUS 10530087 698935 65008052 TMC 10530087 684192 684193 6989635 61020957

- Bolt or Stud – 1/2-13 or 1/2-20
- ⊗ Air Fitting – 1/4 NPTF
- ⊙ Stud – 3/4-10
- ⊕ Tapped Hole on Top Retainers – 3/8-16, on Pistons – 1/2-13
- ⊗ Air Fitting – 1/2 NPTF or 3/8 NPTF
- ⊙ Combination Stud Air Fitting: Stud – 3/4-16, Air Fitting – 1/4 NPTF

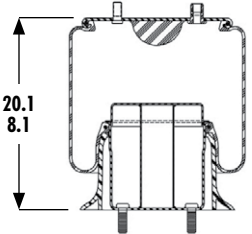
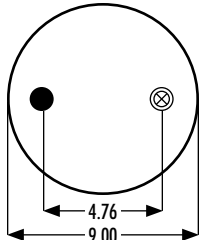
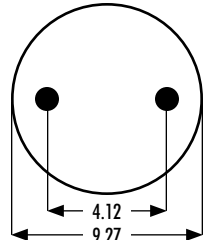
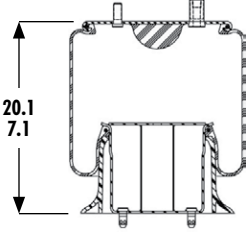
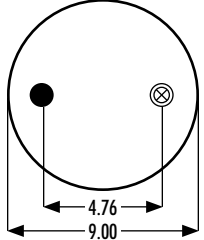
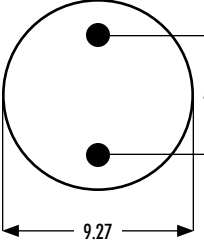
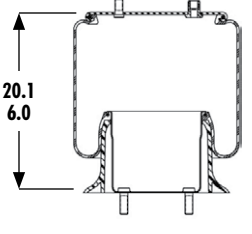
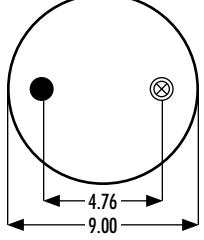
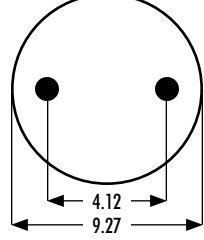
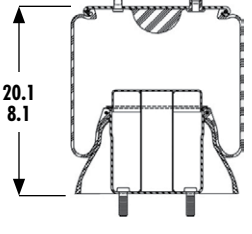
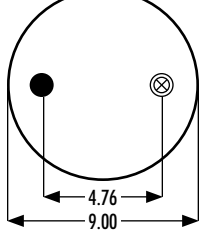
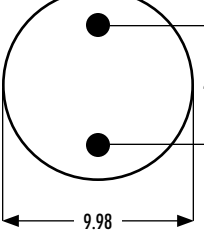
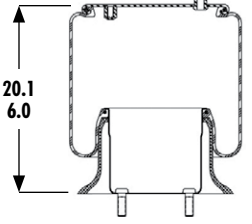
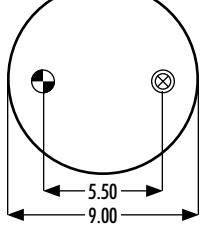
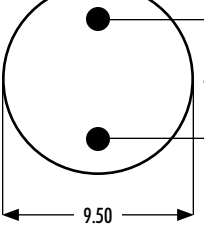
BELLOWS NUMBER	SIDE VIEW WITH EXTENDED AND COMPRESSED HEIGHT	UPPER MOUNTING VIEW	LOWER MOUNTING VIEW	MANUFACTURER NUMBERS
566-22-3-021 PISTON 566-20-7-240 COMPOSITE	1R10-091 	ASA-92-8-152 		FIRESTONE 9380 W013589380 FLXIBLE 6-336-15 6-336-182 GMC 662744 MCI 12F-4-34 12L-4-261 12L-4-5 12M-4-6
566-22-3-021 PISTON 566-20-7-240 COMPOSITE	1R10-099 	ASA-92-8-309 		DINA 224-B020030 MCI 1496372
566-22-3-021 PISTON 566-20-7-240 COMPOSITE	1R10-105 	ASA-92-8-151 		FIRESTONE 9043 NOVOBUS G1076863
566-22-3-021 PISTON 566-20-7-120 COMPOSITE	1R10-108 	ASA-92-8-152 		FIRESTONE 8899 W013588899 PREVOST 63-0077
566-22-3-021 PISTON 566-20-7-077-03 ALUMINUM	1R10-109 	ASA-92-8-017 		ORION 020117511-4 T14-1044

- Bolt or Stud – 1/2-13 or 1/2-20
- ⊗ Air Fitting – 1/4 NPTF
- ⊙ Stud – 3/4-10
- ⊕ Tapped Hole on Top Retainers – 3/8-16, on Pistons – 1/2-13
- ⊗ Air Fitting – 1/2 NPTF or 3/8 NPTF
- ⊙ Combination Stud Air Fitting: Stud – 3/4-16, Air Fitting – 1/4 NPTF

AIR SPRING ROLLING LOBES

AIR SPRING ROLLING LOBES

AIR SPRING ROLLING LOBES

BELLOWS NUMBER	SIDE VIEW WITH EXTENDED AND COMPRESSED HEIGHT	UPPER MOUNTING VIEW	LOWER MOUNTING VIEW	MANUFACTURER NUMBERS
566-22-3-021 PISTON 566-20-7-240 COMPOSITE	1R10-118 	ASA-92-8-179 		
566-22-3-021 PISTON 566-20-7-240 COMPOSITE	1R10-120 	ASA-92-8-162 		AUTOMANN AB1DK20F-9293 NOVABUS N38168 CONTI 9 9K-15 P 424 64388 TRIANGLE 8424 TRP AS92930 FIRESTONE 9293 W013589293 NEWAY 905-57-120
566-22-3-021 PISTON 566-20-7-237 COMPOSITE	1R10-122 	ASA-92-8-164 		AUTOMANN AB1DK20F-9291 TRIANGLE 8425 CONTI 9 9K-15 P 425 64389 TRP AS92910 FIRESTONE 9291 W013589291 NEWAY 905-57-122 905-57-139
566-22-3-021 PISTON 566-20-7-240 COMPOSITE	1R10-127 	ASA-92-8-102 		ORION 20117526
566-22-3-021 PISTON 566-20-7-240 COMPOSITE	1R10-133 	ASA-92-8-152 		FIRESTONE W013589592

- Bolt or Stud – 1/2-13 or 1/2-20
- ⊗ Air Fitting – 1/4 NPTF
- ⊙ Stud – 3/4-10
- ⊕ Tapped Hole on Top Retainers – 3/8-16, on Pistons – 1/2-13
- ⊗ Air Fitting – 1/2 NPTF or 3/8 NPTF
- ⊙ Combination Stud Air Fitting: Stud – 3/4-16, Air Fitting – 1/4 NPTF

BELLOWS NUMBER	SIDE VIEW WITH EXTENDED AND COMPRESSED HEIGHT	UPPER MOUNTING VIEW	LOWER MOUNTING VIEW	MANUFACTURER NUMBERS
566-22-3-021 PISTON 566-20-7-240 COMPOSITE	1R10-165 	ASA-92-8-407 		
566-22-3-021 PISTON 566-20-7-387 COMPOSITE	1R10-171 	ASA-92-8-355 		
566-22-3-021 PISTON 566-20-7-014 STEEL	1R11-028 	ASA-92-8-024 		AUTOMANN AB1DK20D-9422 KENWORTH K-303-14 K-303-15 K-303-6 LOAD GUARD SC2050 DAYTON 352-9422 SPRINGRIDE 1R11-028 FIRESTONE 9422 W013589422 TOYO TRL230H360382 FLEETRITE 1R11-278 TRIANGLE 8314 INT'L/NAVISTAR TRP AS94220 554762C1 WATSON & CHALLIN AS-0017
566-22-3-021 PISTON 566-20-7-014 STEEL	1R11-047 	ASA-92-8-005 		MCI 121-3-53
566-22-3-021 PISTON 566-20-7-055 ALUMINUM	1R11-066 	ASA-92-8-327 		FIRESTONE 9447 W013589447 RIDEWELL 1003589447C

- Bolt or Stud – 1/2-13 or 1/2-20
- ⊗ Air Fitting – 1/4 NPTF
- ⊙ Stud – 3/4-10
- ⊕ Tapped Hole on Top Retainers – 3/8-16, on Pistons – 1/2-13
- ⊗ Air Fitting – 1/2 NPTF or 3/8 NPTF
- ⊙ Combination Stud Air Fitting: Stud – 3/4-16, Air Fitting – 1/4 NPTF

AIR SPRING ROLLING LOBES

AIR SPRING ROLLING LOBES

BELLOWS NUMBER	SIDE VIEW WITH EXTENDED AND COMPRESSED HEIGHT	UPPER MOUNTING VIEW	LOWER MOUNTING VIEW	MANUFACTURER NUMBERS
566-22-3-021 PISTON 566-20-7-055 ALUMINUM	 1R11-150	 ASA-92-8-162	 4.12 8.60	AUTOMANN AB1DK20D-9448 CONTI 9 9-12 P 563 64286 FIRESTONE 9448 W013589448 RIDEWELL 1003589448C TRIANGLE 8563 TRP AS94480
566-22-3-021 PISTON 566-20-7-055 ALUMINUM	 1R11-151	 ASA-92-8-162	 4.12 8.60	BLUEBIRD 1286814 FIRESTONE 9457 W013589457 RIDEWELL 1003589457C
566-22-3-021 PISTON 566-20-7-055 ALUMINUM	 1R11-152	 ASA-92-8-162	 8.60	CHANCE BUS 23891728 FIRESTONE 9459 W013589459 RIDEWELL 1003589459C
566-22-3-021 PISTON 566-20-7-014 STEEL	 1R11-159	 ASA-92-8-162	 9.25	AUTOMANN AB1DK20D-9387 CONTI 9 9-12 P 479 64367 FIRESTONE 9387 W013589387 TRP AS93920
566-22-3-021 PISTON 566-20-7-014 STEEL	 1R11-162	 ASA-92-8-164	 9.25	

- Bolt or Stud – 1/2-13 or 1/2-20
- ⊗ Air Fitting – 1/4 NPTF
- ⊙ Stud – 3/4-10
- ⊕ Tapped Hole on Top Retainers – 3/8-16, on Pistons – 1/2-13
- ⊗ Air Fitting – 1/2 NPTF or 3/8 NPTF
- ⊙ Combination Stud Air Fitting: Stud – 3/4-16, Air Fitting – 1/4 NPTF

AIR SPRING ROLLING LOBES

BELLOWS NUMBER	SIDE VIEW WITH EXTENDED AND COMPRESSED HEIGHT	UPPER MOUNTING VIEW	LOWER MOUNTING VIEW	MANUFACTURER NUMBERS
566-22-3-021 PISTON 566-20-7-252 COMPOSITE	 1R11-200	 ASA-92-8-003	 4.12 9.30	AUTOMANN AB1DK20D-9376 CONTI 9 9-12 P 477 64365 FIRESTONE 9376 W013589376 MCI 14002 MONOCO COACH 14002 TRIANGLE 8477 TRP AS93760
566-22-3-021 PISTON 566-20-7-252 COMPOSITE	 1R11-201	 ASA-92-8-017	 4.12 9.30	AUTOMANN AB1DK20D-9377 CONTI 9 9-12 P 478 64366 FIRESTONE 9377 W013589377 REYCO 21054-01 TRIANGLE 8478 TRP AS93770
566-22-3-021 PISTON 566-20-7-252 COMPOSITE	 1R11-202	 ASA-92-8-164	 4.12 9.30	AUTOMANN AB1DK20D-9378 CONTI 9 9-12 P 447 64363 FIRESTONE 9378 W013589378 RIDEWELL 1003589378C TRIANGLE 8447 TRP AS93780
566-22-3-021 PISTON 566-20-7-251 COMPOSITE	 1R11-203	 ASA-92-8-164	 9.20	CONTI 9 9-12 P 479 64367 FIRESTONE 9387 W013589387 RIDEWELL 1003589387C TRIANGLE 8479 TRP AS93870
566-22-3-021 PISTON 566-20-7-253 COMPOSITE	 1R11-204	 ASA-92-8-164	 4.12 9.30	AUTOMANN AB1DK20D-8900 CONTI 9 9-12 P 401 64362 FIRESTONE 8900 W013588900 REYCO 17361-01 TRIANGLE 8401

- Bolt or Stud – 1/2-13 or 1/2-20
- ⊗ Air Fitting – 1/4 NPTF
- ⊙ Stud – 3/4-10
- ⊕ Tapped Hole on Top Retainers – 3/8-16, on Pistons – 1/2-13
- ⊗ Air Fitting – 1/2 NPTF or 3/8 NPTF
- ⊙ Combination Stud Air Fitting: Stud – 3/4-16, Air Fitting – 1/4 NPTF

AIR SPRING ROLLING LOBES

AIR SPRING ROLLING LOBES

BELLOWS NUMBER	SIDE VIEW WITH EXTENDED AND COMPRESSED HEIGHT	UPPER MOUNTING VIEW	LOWER MOUNTING VIEW	MANUFACTURER NUMBERS
566-22-3-021 PISTON 566-20-7-253 COMPOSITE	1R11-205 	ASA-92-8-017 		AUTOMANN AB1DK200-9476 CONTI 64368 9 9-12 P 516 FIRESTONE 9476 W013589476 REYCO 20446-01 TRIANGLE 8516 TRP AS94760
566-22-3-021 PISTON 566-20-7-156 COMPOSITE	1R11-207 	ASA-92-8-269 		
566-22-3-021 PISTON 566-20-7-287 STEEL	1R11-219 	ASA-92-8-374 SAE 45° flare, .500 O.D. tube SAE J512, .750-16 UNF-2A 		AUTOMANN AB1DK206-9617 CONTI 66112 9 9-9 P 860 FIRESTONE 9617 W013589617 KENWORTH K-303-18 TRIANGLE 8514
566-22-3-021 PISTON 566-20-7-286 STEEL	1R11-220 	ASA-92-8-374 SAE 45° flare, .500 O.D. tube SAE J512, .750-16 UNF-2A 		AUTOMANN AB1DK20H-9618 CONTI 66113 9 9-10 P 862 FIRESTONE 9618 W013589618 KENWORTH K-303-19
566-22-3-021 PISTON 566-20-7-287 STEEL	1R11-221 	ASA-92-8-373 JIC 37° flare, 1.0 O.D. tube SAE J514, 1.312-12 UNF-2A 		AUTOMANN AB1DK206-9622 AB1DK20H-9675 CONTI 65367 9 9-9 P 537 FIRESTONE 9622 9675 W013589622 W013589675 KENWORTH K-303-22 K-303-28 SRINGRIDE 1R11-280 TRIANGLE 8537 TRP AS96750

- Bolt or Stud – 1/2-13 or 1/2-20
- ⊗ Air Fitting – 1/4 NPTF
- ⊙ Stud – 3/4-10
- ⊕ Tapped Hole on Top Retainers – 3/8-16, on Pistons – 1/2-13
- ⊗ Air Fitting – 1/2 NPTF or 3/8 NPTF
- ⊙ Combination Stud Air Fitting: Stud – 3/4-16, Air Fitting – 1/4 NPTF

AIR SPRING ROLLING LOBES

BELLOWS NUMBER	SIDE VIEW WITH EXTENDED AND COMPRESSED HEIGHT	UPPER MOUNTING VIEW	LOWER MOUNTING VIEW	MANUFACTURER NUMBERS
566-22-3-021 PISTON 566-20-7-286 STEEL	1R11-222 	ASA-92-8-373 JIC 37° flare, 1.0 O.D. tube SAE J514, 1.312-12 UNF-2A 		AUTOMANN AB1DK20H-9625 CONTI 65389 9 9-10 P 538 FIRESTONE 9625 W013589625 KENWORTH K-303-25 TRIANGLE 8538 TRP AS96250
566-22-3-021 PISTON 566-20-7-253 COMPOSITE	1R11-241 	ASA-92-8-164 		
566-22-3-021 PISTON 566-20-7-252 COMPOSITE	1R11-242 	ASA-92-8-437 		AUTOMANN AB1DK200-9616 CONTI 64256 9 9-12 P 515 FIRESTONE 9616 W013589616 KENWORTH K-303-16 TRIANGLE 8515 TRP AS96160
566-22-3-021 PISTON 566-20-7-287 STEEL	1R11-268 	ASA-92-8-480 JIC 37° flare, 1.0 O.D. tube SAE J514, 1.312-12 UNF-2A 		AUTOMANN AB1DK206-9547 AB1DK20H-9541 CONTI 66109 9 9-9 P 859 FIRESTONE 9541 9542 9547 W013589542 W013589547 W015449542
566-22-3-022 PISTON 566-20-7-240 COMPOSITE	1R10-019 	ASA-92-8-151 		FIRESTONE 9115 W013589115 FLXIBLE 6-336-209 GMC 2475408 684242 716110

- Bolt or Stud – 1/2-13 or 1/2-20
- ⊗ Air Fitting – 1/4 NPTF
- ⊙ Stud – 3/4-10
- ⊕ Tapped Hole on Top Retainers – 3/8-16, on Pistons – 1/2-13
- ⊗ Air Fitting – 1/2 NPTF or 3/8 NPTF
- ⊙ Combination Stud Air Fitting: Stud – 3/4-16, Air Fitting – 1/4 NPTF

AIR SPRING ROLLING LOBES

AIR SPRING ROLLING LOBES

BELLOWS NUMBER	SIDE VIEW WITH EXTENDED AND COMPRESSED HEIGHT	UPPER MOUNTING VIEW	LOWER MOUNTING VIEW	MANUFACTURER NUMBERS
566-22-3-022 PISTON NOT INCLUDED	1R10-030 	ASA-92-8-151 	USE EXISTING SUPER CUSHION PISTON	GMC 667513A 667513C 720414
566-22-3-023 PISTON 566-20-7-240 COMPOSITE	1R10-137 	ASA-92-8-429 		
566-22-3-027 PISTON 566-20-7-150 STEEL	1R10-101 	ASA-92-8-179 		FIRESTONE 5770 W013585770 MCI 39390246
566-22-3-028 PISTON 566-20-7-055 ALUMINUM	1R11-075 	AS1-92-8-163 		
566-22-3-029 PISTON 566-20-7-055 ALUMINUM	1R10-072 	ASA-92-8-162 		

- Bolt or Stud – 1/2-13 or 1/2-20
- ⊗ Air Fitting – 1/4 NPTF
- ⊙ Stud – 3/4-10
- ⊕ Tapped Hole on Top Retainers – 3/8-16, on Pistons – 1/2-13
- ⊗ Air Fitting – 1/2 NPTF or 3/8 NPTF
- ⊙ Combination Stud Air Fitting: Stud – 3/4-16, Air Fitting – 1/4 NPTF

AIR SPRING ROLLING LOBES

BELLOWS NUMBER	SIDE VIEW WITH EXTENDED AND COMPRESSED HEIGHT	UPPER MOUNTING VIEW	LOWER MOUNTING VIEW	MANUFACTURER NUMBERS
566-22-3-042 PISTON 566-20-7-235 COMPOSITE	1R11-252 	ASA-92-8-164 		AUTOMANN AB1DK23P-8903 CONTI 910-17.5 P 536 64423 FIRESTONE W013588903 TRP AS89030
566-22-3-044 PISTON 566-20-7-079 STEEL	1R11-097 	ASA-92-8-152 		PREVOST 63-0129
566-22-3-049 PISTON 566-20-7-124 STEEL	1R11-130 	ASA-92-8-005 		NOVABUS N17842
566-22-3-049 PISTON 566-20-7-240 COMPOSITE	1R11-189 	ASA-92-8-309 		MCI 1498928
566-22-3-049 PISTON 566-20-7-253 COMPOSITE	1R11-225 	ASA-92-8-164 		FIRESTONE 9650 W013589650 NEWAY 905-57-097

- Bolt or Stud – 1/2-13 or 1/2-20
- ⊗ Air Fitting – 1/4 NPTF
- ⊙ Stud – 3/4-10
- ⊕ Tapped Hole on Top Retainers – 3/8-16, on Pistons – 1/2-13
- ⊗ Air Fitting – 1/2 NPTF or 3/8 NPTF
- ⊙ Combination Stud Air Fitting: Stud – 3/4-16, Air Fitting – 1/4 NPTF

AIR SPRING ROLLING LOBES

AIR SPRING ROLLING LOBES

AIR SPRING ROLLING LOBES

BELLOWS NUMBER	SIDE VIEW WITH EXTENDED AND COMPRESSED HEIGHT	UPPER MOUNTING VIEW	LOWER MOUNTING VIEW	MANUFACTURER NUMBERS
566-22-3-051 PISTON 566-20-7-183 STEEL	1R11-115 	ASA-92-8-271 		MCI 12-03-1041
566-22-3-057 PISTON 566-20-7-150 STEEL	1R11-161 	ASA-92-8-115 		AMERICAN CARRIER 8003023 FIRESTONE 5766 W013585766 HUTCHENS IND. 19141-01
566-22-3-057 PISTON 566-20-7-150 STEEL	1R11-171 	ASA-92-8-164 		AMERICAN CARRIER 8003003 AUTOMANN AB1DK200-9421 CONTI 9 9-12 P 705 64627 FIRESTONE 9421 W013589421 TRIANGLE 8468 TRP AS94210
566-22-3-057 PISTON 566-20-7-308 COMPOSITE	1R11-224 	ASA-92-8-151 		
566-22-3-060 PISTON 566-20-7-257 COMPOSITE	1R11-175 	ASA-92-8-355 		INT'L/ NAVISTAR 3541733C1

- Bolt or Stud – 1/2-13 or 1/2-20
- ⊗ Air Fitting – 1/4 NPTF
- ⊙ Stud – 3/4-10
- ⊕ Tapped Hole on Top Retainers – 3/8-16, on Pistons – 1/2-13
- ⊗ Air Fitting – 1/2 NPTF or 3/8 NPTF
- ⊙ Combination Stud Air Fitting: Stud – 3/4-16, Air Fitting – 1/4 NPTF

BELLOWS NUMBER	SIDE VIEW WITH EXTENDED AND COMPRESSED HEIGHT	UPPER MOUNTING VIEW	LOWER MOUNTING VIEW	MANUFACTURER NUMBERS
566-22-3-068 PISTON 566-20-7-257 COMPOSITE	1R11-216 	ASA-92-8-355 		
566-22-3-073 PISTON 566-20-7-156 COMPOSITE	1R11-223 	ASA-92-8-005 		FIRESTONE 9469 W013589469
566-22-3-075 PISTON 566-20-7-257 COMPOSITE	1R11-176 	ASA-92-8-355 		
566-22-3-079 PISTON 566-20-7-079 STEEL	1R11-244 	ASA-92-8-438 		PREVOST 63-0102 63-0126 63-0259
566-22-3-084 PISTON 566-20-7-156 COMPOSITE	1R11-249 	ASA-92-8-367 		FIRESTONE W013588616 NABI-HF 633-9668

- Bolt or Stud – 1/2-13 or 1/2-20
- ⊗ Air Fitting – 1/4 NPTF
- ⊙ Stud – 3/4-10
- ⊕ Tapped Hole on Top Retainers – 3/8-16, on Pistons – 1/2-13
- ⊗ Air Fitting – 1/2 NPTF or 3/8 NPTF
- ⊙ Combination Stud Air Fitting: Stud – 3/4-16, Air Fitting – 1/4 NPTF

AIR SPRING ROLLING LOBES

AIR SPRING ROLLING LOBES

AIR SPRING ROLLING LOBES

BELLOWS NUMBER	SIDE VIEW WITH EXTENDED AND COMPRESSED HEIGHT	UPPER MOUNTING VIEW	LOWER MOUNTING VIEW	MANUFACTURER NUMBERS
566-22-3-095 PISTON 566-20-7-425 COMPOSITE	1R11-292 	ASA-92-8-238 	566-20-7-425 	AUTOMANN AB1DK20J-9626 CONTI 9 9-16 P 568 HENDRICKSON S23720 FIRESTONE W01-358-9626
566-22-3-143 PISTON 566-20-7-036 ALUMINUM	1R11-039 	ASA-92-8-005 		AUTOMANN AB1DK20E-9439 CONTI 9 9-14 A 337 64379 FIRESTONE 9439 W013589439 TRIANGLE 8337
566-22-3-143 PISTON 566-20-7-077-03 ALUMINUM	1R11-045 	ASA-92-8-164 		
566-22-3-143 PISTON 566-20-7-120 COMPOSITE	1R11-088 	ASA-92-8-152 		FIRESTONE 5739 W013585739 PREVOST 63-0092 63-0104
566-22-3-143 PISTON 566-20-7-079 STEEL	1R11-090 	ASA-92-8-438 1.250-12 UNF outside 500-14 NPTF inside 		PREVOST 63-0090 63-0094 63-0106

- Bolt or Stud – 1/2-13 or 1/2-20
- ⊗ Air Fitting – 1/4 NPTF
- ⊙ Stud – 3/4-10
- ⊕ Tapped Hole on Top Retainers – 3/8-16, on Pistons – 1/2-13
- ⊗ Air Fitting – 1/2 NPTF or 3/8 NPTF
- ⊙ Combination Stud Air Fitting: Stud – 3/4-16, Air Fitting – 1/4 NPTF

BELLOWS NUMBER	SIDE VIEW WITH EXTENDED AND COMPRESSED HEIGHT	UPPER MOUNTING VIEW	LOWER MOUNTING VIEW	MANUFACTURER NUMBERS
566-22-3-143 PISTON 566-20-7-240 COMPOSITE	1R11-094 	ASA-92-8-179 		
566-22-3-143 PISTON NOT INCLUDED	1R11-109 	ASA-92-8-438 500-14 NPTF 	USE EXISTING SUPER CUSHION PISTON	PREVOST 63-0109
566-22-3-143 PISTON 566-20-7-156 COMPOSITE	1R11-121 	ASA-92-8-005 		CONTI 9 9-14 A 337 64379 FIRESTONE 9441 W013589441 FLXIBLE 6-366-200 GILLIG 53-13187 53-14006 53-8212 NOVABUS N16374
566-22-3-143 PISTON 566-20-7-240 COMPOSITE	1R11-143 	ASA-92-8-304 M22 x 1.5-6G outside 250-18 NPTF inside M12 x 1.75-6G 		DINA 224-B020020 MCI 12-03-6034 1512076
566-22-3-143 PISTON 566-20-7-240 COMPOSITE	1R11-147 	ASA-92-8-102 		ORION 20217501

- Bolt or Stud – 1/2-13 or 1/2-20
- ⊗ Air Fitting – 1/4 NPTF
- ⊙ Stud – 3/4-10
- ⊕ Tapped Hole on Top Retainers – 3/8-16, on Pistons – 1/2-13
- ⊗ Air Fitting – 1/2 NPTF or 3/8 NPTF
- ⊙ Combination Stud Air Fitting: Stud – 3/4-16, Air Fitting – 1/4 NPTF

AIR SPRING ROLLING LOBES

AIR SPRING ROLLING LOBES

AIR SPRING ROLLING LOBES

BELLOWS NUMBER	SIDE VIEW WITH EXTENDED AND COMPRESSED HEIGHT	UPPER MOUNTING VIEW	LOWER MOUNTING VIEW	MANUFACTURER NUMBERS
566-22-3-143 PISTON 566-20-7-239 COMPOSITE	1R11-149 	ASA-92-8-142 		AUTOMANN AB1DK20D-8901 CONTI 9 9-12 P 464 64364 FIRESTONE 8901 W013588901
566-22-3-143 PISTON 566-20-7-235 COMPOSITE	1R11-166 	ASA-92-8-164 		AUTOMANN AB1DK20F-9295 CONTI 9 9K-15 P 417 64386 FIRESTONE 9295 W013589295 NEWAY 905-57-121
566-22-3-143 PISTON 566-20-7-250 COMPOSITE	1R11-169 	ASA-92-8-151 		NOVABUS G1202328 G1202651 G1202652
566-22-3-143 PISTON 566-20-7-240 COMPOSITE	1R11-170 	ASA-92-8-165 		
566-22-3-143 PISTON 566-20-7-209 COMPOSITE	1R11-178 	ASA-92-8-005 		AUTOMANN AB1DK20D-9379 AB1DK20E-9385 CONTI 9 9-14 P 895 67492 FIRESTONE W01W359385 NEW FLYER 55089 TRP AS93850

- Bolt or Stud – 1/2-13 or 1/2-20
- ⊗ Air Fitting – 1/4 NPTF
- ⊙ Stud – 3/4-10
- ⊕ Tapped Hole on Top Retainers – 3/8-16, on Pistons – 1/2-13
- ⊗ Air Fitting – 1/2 NPTF or 3/8 NPTF
- ⊙ Combination Stud Air Fitting: Stud – 3/4-16, Air Fitting – 1/4 NPTF

BELLOWS NUMBER	SIDE VIEW WITH EXTENDED AND COMPRESSED HEIGHT	UPPER MOUNTING VIEW	LOWER MOUNTING VIEW	MANUFACTURER NUMBERS
566-22-3-143 PISTON 566-20-7-209 COMPOSITE	1R11-179 	ASA-92-8-005 		AUTOMANN AB1DK20E-9465 AB1DK20E-P708 CONTI 9 9-14 P 708 64631 FIRESTONE W01W359465 NEW FLYER 99865
566-22-3-143 PISTON 566-20-7-239 COMPOSITE	1R11-191 	ASA-92-8-005 		AUTOMANN AB1DK20E-8919 CONTI 9 9-14 P 517 64381 FIRESTONE 8919 W013588919 RIDEWELL T003588919C TRIANGLE 8517
566-22-3-143 PISTON 566-20-7-209 COMPOSITE	1R11-209 	ASA-92-8-151 		
566-22-3-143 PISTON 566-20-7-124 STEEL	1R11-232 	ASA-92-8-257 		NOVABUS N35162
566-22-3-143 PISTON 566-20-7-120 COMPOSITE	1R11-243 	ASA-92-8-438 		PREVOST 63-0093 63-0099 63-0105 63-0260

- Bolt or Stud – 1/2-13 or 1/2-20
- ⊗ Air Fitting – 1/4 NPTF
- ⊙ Stud – 3/4-10
- ⊕ Tapped Hole on Top Retainers – 3/8-16, on Pistons – 1/2-13
- ⊗ Air Fitting – 1/2 NPTF or 3/8 NPTF
- ⊙ Combination Stud Air Fitting: Stud – 3/4-16, Air Fitting – 1/4 NPTF

AIR SPRING ROLLING LOBES

AIR SPRING ROLLING LOBES

AIR SPRING ROLLING LOBES

BELLOWS NUMBER	SIDE VIEW WITH EXTENDED AND COMPRESSED HEIGHT	UPPER MOUNTING VIEW	LOWER MOUNTING VIEW	MANUFACTURER NUMBERS
566-24-1-012 PISTON 566-20-7-246 STEEL	1R12-424 	ASA-92-8-199 		CONTI 9 10-18.5 P 406 64277 FIRESTONE 9287 W013589287 GMC 15963160 HENDRICKSON 50405 50405-1 50405-2 TRIANGLE 8406 TRP AS92870
566-24-3-024 PISTON 566-20-7-240 COMPOSITE	1R12-127 	ASC-20-8-003 		PREVOST 63-0040 63-0064
566-24-3-038 PISTON 566-20-7-080 COMPOSITE	1R12-066 	ASA-92-8-164 		AUTOMANN AB1DK23K-9083 CONTI 9 10-16 P 333 64294 DAYTON 352-9069 352-9083 FIRESTONE 9083 W013589083 GRANNING 1359 1528 B59 INT'L/NAVISTAR 554763C1 LOAD GUARD SC2036 RIDEWELL 1003589083C TAURUS AS506-9080 TRIANGLE 8333 TRP AS90830 WATSON & CHALIN AS-0018 AS-0028
566-24-3-038 PISTON 566-20-7-235 COMPOSITE	1R12-069 	ASA-92-8-041 		AUTOMANN AB1DK231-9069 AB1DK231-9069 CONTI 9 10-14 P 312 64274 DAYTON 352-9069 FIRESTONE 9069 W013589069 FLEETRITE 1R12-1052 INT'L/NAVISTAR 554764C1 LOAD GUARD SC2034 PETERBILT 03-01649 03-02456 03-04759 03-07112 23-10042 SPRINGRIDE 1R12-1069 TAURUS AS504-9069 AS506-9069 TRIANGLE 8312 TRP AS90690 WATSON & CHALIN AS-0077

- Bolt or Stud – 1/2-13 or 1/2-20
- ⊗ Air Fitting – 1/4 NPTF
- ⊙ Stud – 3/4-10
- ⊕ Tapped Hole on Top Retainers – 3/8-16, on Pistons – 1/2-13
- ⊗ Air Fitting – 1/2 NPTF or 3/8 NPTF
- ⊙ Combination Stud Air Fitting: Stud – 3/4-16, Air Fitting – 1/4 NPTF

BELLOWS NUMBER	SIDE VIEW WITH EXTENDED AND COMPRESSED HEIGHT	UPPER MOUNTING VIEW	LOWER MOUNTING VIEW	MANUFACTURER NUMBERS
566-24-3-038 PISTON 566-20-7-079 STEEL	1R12-090 	ASA-92-8-052 		AUTOMANN AB1DK23K-9213 CONTI 9 10-16 P 407 64262 DAYTON 352-9213 FIRESTONE 9213 W013589213 FLEETRITE 1R12-1060 INT'L/NAVISTAR 1660581C1 1660581C1 501559C1 501559C2 LOAD GUARD SC2048 SPRINGRIDE 1R12-1060 TRIANGLE 8407 TRP AS92130
566-24-3-038 PISTON NOT INCLUDED	1R12-093 	ASA-92-8-164 	USE EXISTING SUPER CUSHION PISTON	HUTCHENS IND. 9630-03 INT'L/NAVISTAR 554765C1 LOAD GUARD SC2054 NEWAY 900-44-200 900-44-216 900-44-647 RIDEWELL 1013580712C TAURUS AS506-0712
566-24-3-038 PISTON 566-20-7-080 COMPOSITE	1R12-130 	ASA-92-8-005 		AUTOMANN AB1DK23K-9227 CONTI 9 10-16 P 353 64298 FIRESTONE 9227 W013589227 HENDRICKSON B-2924 TRIANGLE 8353
566-24-3-038 REPLACED BY 1R12-358	1R12-155 OBSOLETE 	ASA-92-8-002 		AUTOMANN AB1DK23K-9096 CONTI 9 10-16 P 325 64292 FIRESTONE 9096 W013589096 FRUEHAUF UCE-1304-1 TRIANGLE 8325
566-24-3-038 PISTON 566-20-7-079 STEEL	1R12-182 	ASA-92-8-004 		AUTOMANN AB1DK23K-9219 CONTI 9 10-16 P 408 64259 FIRESTONE 9219 W013589219 INT'L/NAVISTAR 1681739C1 LOAD GUARD SC2070 TRIANGLE 8408 TRP AS92190 VOLVO 35003-3201 35003-3203 35003-3204 35003-3209

- Bolt or Stud – 1/2-13 or 1/2-20
- ⊗ Air Fitting – 1/4 NPTF
- ⊙ Stud – 3/4-10
- ⊕ Tapped Hole on Top Retainers – 3/8-16, on Pistons – 1/2-13
- ⊗ Air Fitting – 1/2 NPTF or 3/8 NPTF
- ⊙ Combination Stud Air Fitting: Stud – 3/4-16, Air Fitting – 1/4 NPTF

AIR SPRING ROLLING LOBES

AIR SPRING ROLLING LOBES

AIR SPRING ROLLING LOBES

BELLOWS NUMBER	SIDE VIEW WITH EXTENDED AND COMPRESSED HEIGHT	UPPER MOUNTING VIEW	LOWER MOUNTING VIEW	MANUFACTURER NUMBERS
566-24-3-038 PISTON 566-20-7-079 STEEL	1R12-188 	ASA-92-8-162 		AUTOMANN AB1DK23K-9223 REYCO 12884-01, 12884-01A CONTI 9 10-16 P 409, 64275 TRIANGLE 8409 FIRESTONE 9223, W013589223 TRP AS92230 HENDRICKSON 48195
566-24-3-038 PISTON 566-20-7-080 COMPOSITE	1R12-220 	ASA-92-8-164 		AUTOMANN AB1DK23K-9092 INT'L/NAVISTAR 517096C91 CONTI 9 10-16 P 372, 64301 NEWAY 905-57-031 FIRESTONE 9092, W013589092 TRIANGLE 8372 HENDRICKSON B-12353
566-24-3-038 PISTON 566-20-7-080 COMPOSITE	1R12-285 	ASC-92-8-088 		AUTOMANN AB1DK23I-9060 CONTI 9 10-14 P 709, 64632 FIRESTONE W359060 NEW FLYER 14635, 65
566-24-3-038 PISTON 566-20-7-080 COMPOSITE	1R12-356 	ASA-92-8-258 		AUTOMANN AB1DK23K-9194 PETERBILT 03-05107 CONTI 9 10-16 P 352, 64297 TAURUS AS506-9194 TRIANGLE 8352 DAYTON 352-9194 TRP AS91940 FIRESTONE 9194, W013589194 WATSON & CHALIN AS-0101
566-24-3-038 PISTON 566-20-7-080 COMPOSITE	1R12-358 	ASA-92-8-003 		CONTI 9 10-16 P 325, 64292 TAURUS AS504-9096 DAYTON 352-9096 TRIANGLE 8325 FIRESTONE 9096, W013589096 FRUEHAUF UCE-1304-1

- Bolt or Stud – 1/2-13 or 1/2-20
- ⊗ Air Fitting – 1/4 NPTF
- ⊙ Stud – 3/4-10
- ⊕ Tapped Hole on Top Retainers – 3/8-16, on Pistons – 1/2-13
- ⊗ Air Fitting – 1/2 NPTF or 3/8 NPTF
- ⊙ Combination Stud Air Fitting: Stud – 3/4-16, Air Fitting – 1/4 NPTF

BELLOWS NUMBER	SIDE VIEW WITH EXTENDED AND COMPRESSED HEIGHT	UPPER MOUNTING VIEW	LOWER MOUNTING VIEW	MANUFACTURER NUMBERS
566-24-3-038 PISTON 566-20-7-079 STEEL	1R12-365 	ASA-92-8-121 		CONTI 9 10-16 P 410, 64276 MACK TRUCK 3645Q28, 57QL411M FIRESTONE 9466, W013589466 TRIANGLE 8410 HENDRICKSON 49048, 49674 TRP AS94660
566-24-3-038 PISTON 566-20-7-163 STEEL	1R12-366 	AS1-92-8-192 		AUTOMANN AB1DK23K-9299, AB1DK23P-8944 FIRESTONE CONTI W013588944, W013589015, W013589299 CONTI 9 10-17.5 P 436, 64401 HENDRICKSON C-20217 FIRESTONE 8944, 9015, 9299 TRIANGLE 8436 TRP AS92990
566-24-3-038 PISTON 566-20-7-079 STEEL	1R12-369 	ASA-92-8-165 		DINA 2027911C1
566-24-3-038 PISTON NOT INCLUDED	1R12-394 	ASA-92-8-283 	USE EXISTING SUPER CUSHION PISTON	MCI 12L-1-169 PREVOST 63-0224
566-24-3-038 PISTON 566-20-7-240 COMPOSITE	1R12-396 	ASA-92-8-283 		MCI 12L-1-140 PREVOST 63-0183

- Bolt or Stud – 1/2-13 or 1/2-20
- ⊗ Air Fitting – 1/4 NPTF
- ⊙ Stud – 3/4-10
- ⊕ Tapped Hole on Top Retainers – 3/8-16, on Pistons – 1/2-13
- ⊗ Air Fitting – 1/2 NPTF or 3/8 NPTF
- ⊙ Combination Stud Air Fitting: Stud – 3/4-16, Air Fitting – 1/4 NPTF

AIR SPRING ROLLING LOBES

AIR SPRING ROLLING LOBES

AIR SPRING ROLLING LOBES

BELLOWS NUMBER	SIDE VIEW WITH EXTENDED AND COMPRESSED HEIGHT	UPPER MOUNTING VIEW	LOWER MOUNTING VIEW	MANUFACTURER NUMBERS
566-24-3-038 PISTON 566-20-7-246 STEEL	1R12-400 	ASA-92-8-306 		AUTOMANN AB1DK23K-9296 TRP AS92960 CONTI 9 10-16 P 416 64310 VOLVO 8061151 8169868 FIRESTONE 9296 W013589296 TRIANGLE 8416
566-24-3-038 PISTON 566-20-7-158 COMPOSITE	1R12-436 	ASA-92-8-017 		AUTOMANN AB1DK23K-8924 TRP AS92960 CONTI 9 10-16 P 497 64314 VOLVO 8061151 8169868 FIRESTONE 8924 W013588924 TRIDWELL 1003588924C TRIANGLE 8497
566-24-3-038 PISTON 566-20-7-158 COMPOSITE	1R12-438 	ASA-92-8-017 		AUTOMANN AB1DK23K-8805 TRP AS92960 CONTI 9 10-14 P 462 64474 VOLVO 8061151 8169868 FIRESTONE 8805 W013588805 TRIDWELL 1003588805C TRIANGLE 8462 TRP AS88050
566-24-3-038 PISTON 566-20-7-235 COMPOSITE	1R12-441 	ASA-92-8-164 		AUTOMANN AB1DK23K-9362 TRP AS92960 CONTI 9 10-16 P 391 64304 VOLVO 8061151 8169868 FIRESTONE 9362 W013589362 NEWAY 905-57-113 WATSON & CHALIN AS-0049 TRIANGLE 8391
566-24-3-038 PISTON 566-20-7-079 STEEL	1R12-454 	ASA-92-8-283 		CONTI 910-16P130 69075 MCI 12L-1-215

- Bolt or Stud – 1/2-13 or 1/2-20
- ⊗ Air Fitting – 1/4 NPTF
- ⊙ Stud – 3/4-10
- ⊕ Tapped Hole on Top Retainers – 3/8-16, on Pistons – 1/2-13
- ⊗ Air Fitting – 1/2 NPTF or 3/8 NPTF
- ⊙ Combination Stud Air Fitting: Stud – 3/4-16, Air Fitting – 1/4 NPTF

BELLOWS NUMBER	SIDE VIEW WITH EXTENDED AND COMPRESSED HEIGHT	UPPER MOUNTING VIEW	LOWER MOUNTING VIEW	MANUFACTURER NUMBERS
566-24-3-038 PISTON 566-20-7-246 STEEL	1R12-462 	ASA-92-8-199 		VOLVO 3180984P2
566-24-3-038 PISTON 566-20-7-215 COMPOSITE	1R12-484 	ASA-92-8-269 		AUTOMANN AB1DK23P-9504 CONTI 9 10-17.5 P 574 64418 FIRESTONE 9504 NEWAY 905-57-215
566-24-3-038 PISTON 566-20-7-215 COMPOSITE	1R12-485 	ASA-92-8-269 		CONTI 910-17.5P715 FIRESTONE 9501 NEWAY 905-57-214 TRP AS95010
566-24-3-038 PISTON 566-20-7-215 COMPOSITE	1R12-486 	ASA-92-8-269 		CONTI 910-17.5P574 64418 FIRESTONE 9504 NEWAY 905-57-216
566-24-3-038 PISTON 566-20-7-036 ALUMINUM	1R12-494 	ASA-92-8-331 		AUTOMANN AB1DK23P-A802 CONTI 9 10-17.5 A 802 64762

- Bolt or Stud – 1/2-13 or 1/2-20
- ⊗ Air Fitting – 1/4 NPTF
- ⊙ Stud – 3/4-10
- ⊕ Tapped Hole on Top Retainers – 3/8-16, on Pistons – 1/2-13
- ⊗ Air Fitting – 1/2 NPTF or 3/8 NPTF
- ⊙ Combination Stud Air Fitting: Stud – 3/4-16, Air Fitting – 1/4 NPTF

AIR SPRING ROLLING LOBES

AIR SPRING ROLLING LOBES

AIR SPRING ROLLING LOBES

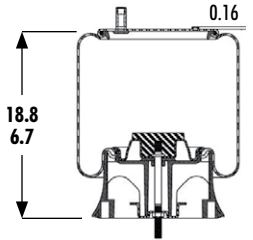
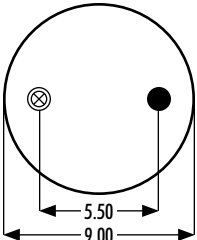
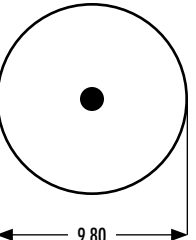
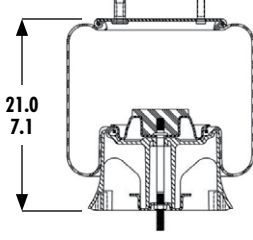
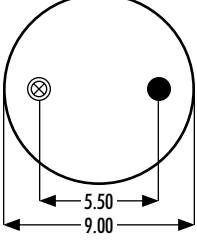
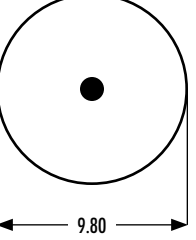
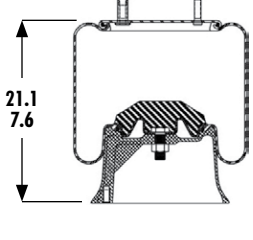
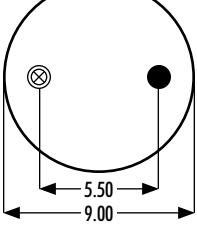
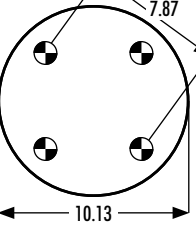
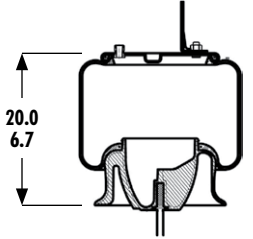
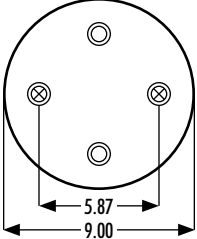
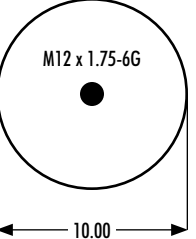
BELLOWS NUMBER	SIDE VIEW WITH EXTENDED AND COMPRESSED HEIGHT	UPPER MOUNTING VIEW	LOWER MOUNTING VIEW	MANUFACTURER NUMBERS
566-24-3-038 PISTON 566-20-7-238 COMPOSITE	1R12-499 	ASA-92-8-331 		AUTOMANN AB1DK23P-9936 CONTI 9 10-17.5 P 454 64405 FIRESTONE 9936 W013589936 NEWAY 905-57-156 TRIANGLE 8454 TRP AS99360
566-24-3-038 PISTON 566-20-7-235 COMPOSITE	1R12-502 	ASA-92-8-164 		AUTOMANN AB1DK23P-9921 CONTI 9 10-17.5 P 443 64402 FIRESTONE 9921 W013589921 NEWAY 905-57-117 TRIANGLE 8443 TRP AS99210 WATSON & CHALIN AS-0090
566-24-3-038 PISTON 566-20-7-005 ALUMINUM	1R12-509 	ASA-92-8-164 		AUTOMANN AB1DK23K-9082A CONTI 9 10-16 P 310 64269 DAYTON 352-9082 FAB TEK 101828 FIRESTONE 9082 W013589082 GRANNING 2727 HDA PMABG-9082B HENDRICKSON 36514-7 B-2066 HUTCHENS IND. 9630-01 INT'L/NAVISTAR 517559C9 KWIK-LOK/TODCO CP-3281 CP-5125 CP-5152 LOAD GUARD SC2035 NEWAY 905-57-006 905-57-027 905-57-037 905-57-054 905-57-075 R&S TRUCK & BODY 1090217 REYCO 12882-01 RIDEWELL 1003589082C S-542-C SUSPENSIONS INC. 201869 TAURUS AS506-9082 TOYO TRL-240/393 TRIANGLE 8310
566-24-3-038 PISTON 566-20-7-236 COMPOSITE	1R12-535 	ASA-92-8-344 		

- Bolt or Stud – 1/2-13 or 1/2-20
- ⊗ Air Fitting – 1/4 NPTF
- ⊙ Stud – 3/4-10
- ⊕ Tapped Hole on Top Retainers – 3/8-16, on Pistons – 1/2-13
- ⊗ Air Fitting – 1/2 NPTF or 3/8 NPTF
- ⊙ Combination Stud Air Fitting: Stud – 3/4-16, Air Fitting – 1/4 NPTF

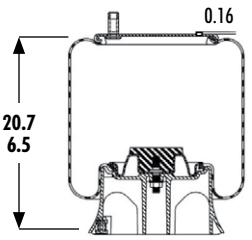
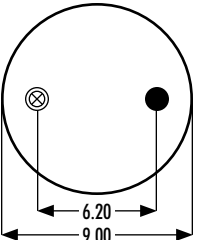
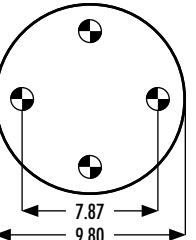
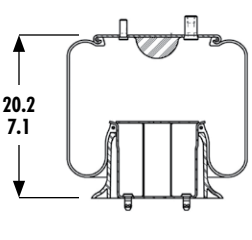
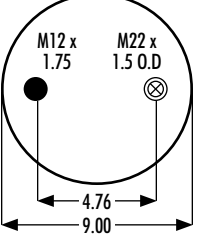
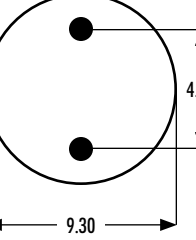
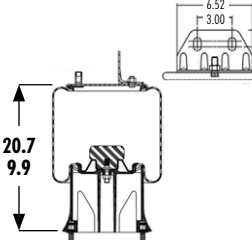
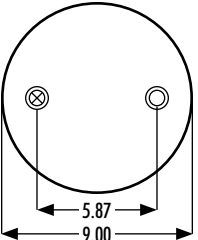
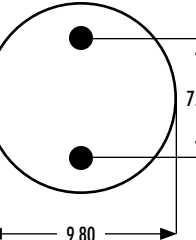
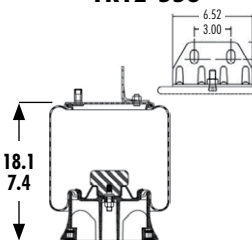
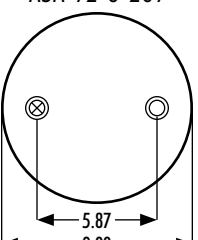
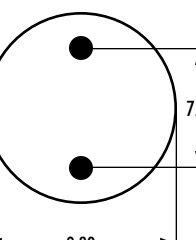
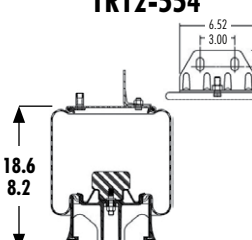
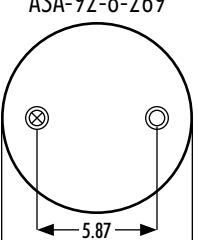
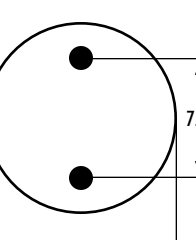
BELLOWS NUMBER	SIDE VIEW WITH EXTENDED AND COMPRESSED HEIGHT	UPPER MOUNTING VIEW	LOWER MOUNTING VIEW	MANUFACTURER NUMBERS
566-24-3-038 PISTON 566-20-7-209 COMPOSITE	1R12-541 	ASA-92-8-360 		AUTOMANN AB1DK23K-P769 CONTI 9 10-16 P 769 64650 64650 WATSON & CHALIN AS-01136
566-24-3-038 PISTON 566-20-7-240 COMPOSITE	1R12-545 	ASA-92-8-309 		MCI 12-04-6007
566-24-3-038 PISTON 566-20-7-215 COMPOSITE	1R12-552 	ASA-92-8-269 		CONTI 910-17-5P572 64416 FIRESTONE 9471 9501 W013589471 NEWAY 905-57-212 TRP AS95010
566-24-3-038 PISTON 566-20-7-213 COMPOSITE	1R12-553 	ASA-92-8-269 		AUTOMANN AB1DK23P-9472 AB1DK23P-P573 AB1DK23Q-9491 CONTI 9 10-17.5 P 573 64417 FIRESTONE 9472 9491 W013589472 W013589491 NEWAY 905-57-213 TRIANGLE 8467 TRP AS94720
566-24-3-038 PISTON 566-20-7-214 COMPOSITE	1R12-554 	ASA-92-8-269 		AUTOMANN AB1DK23P-9470 AB1DK23P-9502 CONTI 9 10-17.5 P 571 64415 FIRESTONE W013589470 NEWAY 905-57-211 TRIANGLE 8501

- Bolt or Stud – 1/2-13 or 1/2-20
- ⊗ Air Fitting – 1/4 NPTF
- ⊙ Stud – 3/4-10
- ⊕ Tapped Hole on Top Retainers – 3/8-16, on Pistons – 1/2-13
- ⊗ Air Fitting – 1/2 NPTF or 3/8 NPTF
- ⊙ Combination Stud Air Fitting: Stud – 3/4-16, Air Fitting – 1/4 NPTF

AIR SPRING ROLLING LOBES

AIR SPRING ROLLING LOBES

BELLOWS NUMBER	SIDE VIEW WITH EXTENDED AND COMPRESSED HEIGHT	UPPER MOUNTING VIEW	LOWER MOUNTING VIEW	MANUFACTURER NUMBERS
566-24-3-038 PISTON 566-20-7-235 COMPOSITE	1R12-567 	ASA-92-8-041 		AUTOMANN AB1DK23K-9026 CONTI 9 10-16 P 393 64306 FIRESTONE 9026 W013589026 PETERBILT 03-06213 03-07111 TRIANGLE 8393 TRP AS90260
566-24-3-038 PISTON 566-20-7-159 COMPOSITE	1R12-576 	ASA-92-8-005 		CONTI 910-16P770 64651
566-24-3-038 PISTON 566-20-7-158 COMPOSITE	1R12-584 	ASA-92-8-331 		RIDEWELL 1001R12584G
566-24-3-038 PISTON 566-20-7-237 COMPOSITE	1R12-586 	ASA-92-8-269 		AUTOMANN AB1DK23P-9473 CONTI 9 10-17.5 P 445 64403 FIRESTONE 9473 W013589473 NEWAY 905-57-152 905-57-179 TRP AS94730
566-24-3-038 PISTON 566-20-7-036 ALUMINUM	1R12-617 	ASA-92-8-164 		

- Bolt or Stud – 1/2-13 or 1/2-20
- ⊗ Air Fitting – 1/4 NPTF
- ⊙ Stud – 3/4-10
- ⊕ Tapped Hole on Top Retainers – 3/8-16, on Pistons – 1/2-13
- ⊗ Air Fitting – 1/2 NPTF or 3/8 NPTF
- ⊙ Combination Stud Air Fitting: Stud – 3/4-16, Air Fitting – 1/4 NPTF

AIR SPRING ROLLING LOBES

BELLOWS NUMBER	SIDE VIEW WITH EXTENDED AND COMPRESSED HEIGHT	UPPER MOUNTING VIEW	LOWER MOUNTING VIEW	MANUFACTURER NUMBERS
566-24-3-038 PISTON 566-20-7-238 COMPOSITE	1R12-640 	ASA-92-8-257 		AUTOMANN AB1DK23P-9902 CONTI 9 10-17.5 P 426 64398 FIRESTONE W013589902
566-24-3-038 PISTON 566-20-7-053 ALUMINUM	1R12-669 	ASA-92-8-021 		CONTI 9 10-14 P 312 64274 DAYTON 352-9069 FIRESTONE 9069 W013589069 INT'L/NAVISTAR 554764C1 LOAD GUARD SC2034 PETERBILT 03-01649 03-02038 03-02456 03-04759 03-07112 23-10042 TAURUS AS504-9069 AS506-9069 TRIANGLE 8312 WATSON & CHALIN AS-0077
566-24-3-048 PISTON 566-20-7-006 ALUMINUM	1R12-143 	ASC-20-8-045 		AUTOMANN AB1DK23K-9392 CONTI 9 10-16 P 376 64302 FIRESTONE 9392 W013589392 HENDRICKSON B-4773 TRIANGLE 8376 TRP AS93920
566-24-3-048 PISTON 566-20-7-120 COMPOSITE	1R12-154 	ASC-20-8-053 		MCI 12L-1-88
566-24-3-048 PISTON 566-20-7-120 COMPOSITE	1R12-217 	UPPER BEAD PLATE NOT INCLUDED. SHOWN FOR REFERENCE ONLY.		MCI 12L-1-104 12L-1-136 PREVOST 63-0181

- Bolt or Stud – 1/2-13 or 1/2-20
- ⊗ Air Fitting – 1/4 NPTF
- ⊙ Stud – 3/4-10
- ⊕ Tapped Hole on Top Retainers – 3/8-16, on Pistons – 1/2-13
- ⊗ Air Fitting – 1/2 NPTF or 3/8 NPTF
- ⊙ Combination Stud Air Fitting: Stud – 3/4-16, Air Fitting – 1/4 NPTF

AIR SPRING ROLLING LOBES

AIR SPRING ROLLING LOBES

BELLOWS NUMBER	SIDE VIEW WITH EXTENDED AND COMPRESSED HEIGHT	UPPER MOUNTING VIEW	LOWER MOUNTING VIEW	MANUFACTURER NUMBERS
566-24-3-048 PISTON 566-20-7-240 COMPOSITE	1R12-284 	UPPER BEAD PLATE NOT INCLUDED. SHOWN FOR REFERENCE ONLY		
566-24-3-048 PISTON 566-20-7-120 COMPOSITE	1R12-288 	ASC-20-8-110 		MCI 12C-1-126 12K-1-45 12L-1-126 PREVOST 63-0180
566-24-3-048 PISTON 566-20-7-240 COMPOSITE	1R12-304 	ASC-20-8-110 		FIRESTONE 9018 W013589018 MCI 12G-1-60 12L-1-133 12L-1-135 12L-1-142 PREVOST 63-0182
566-24-3-048 PISTON 566-20-7-240 COMPOSITE	1R12-511 	UPPER BEAD PLATE NOT INCLUDED. SHOWN FOR REFERENCE ONLY		GMC 15504181 G1015009 G1020956 NOVABUS G1015009 G1202944
566-24-3-061 PISTON 566-20-7-197 ALUMINUM	1R12-350 	ASA-92-8-002 		AUTOMANN AB1DK23F-9031 CONTI 9 10-10 P 339 64433 FIRESTONE 9031 W013589031 PEERLESS 0550-00051

- Bolt or Stud – 1/2-13 or 1/2-20
- ⊗ Air Fitting – 1/4 NPTF
- ⊙ Stud – 3/4-10
- ⊕ Tapped Hole on Top Retainers – 3/8-16, on Pistons – 1/2-13
- ⊗ Air Fitting – 1/2 NPTF or 3/8 NPTF
- ⊙ Combination Stud Air Fitting: Stud – 3/4-16, Air Fitting – 1/4 NPTF

AIR SPRING ROLLING LOBES

BELLOWS NUMBER	SIDE VIEW WITH EXTENDED AND COMPRESSED HEIGHT	UPPER MOUNTING VIEW	LOWER MOUNTING VIEW	MANUFACTURER NUMBERS
566-24-3-061 PISTON 566-20-7-197 ALUMINUM	1R12-351 	ASA-92-8-003 		AUTOMANN AB1DK23F-9033 CONTI 9 10-10 P 328 64430 FIRESTONE 9033 W013589033 NEWAY 905-57-012 AR-1515-1
566-24-3-061 PISTON 566-20-7-197 ALUMINUM	1R12-359 	ASA-92-8-088 		AUTOMANN AB1DK23F-9077 CONTI 9 10-10 P 331 64431 FIRESTONE 9077 W013589077 FRUEHAUF MFR-022354 UCB-4453-1
566-24-3-061 PISTON 566-20-7-014 STEEL	1R12-383 	ASA-92-8-162 		FLXIBLE 97-9999-02185 ORION 010132404-4
566-24-3-061 PISTON 566-20-7-251 COMPOSITE	1R12-530 	ASA-92-8-164 		FIRESTONE 9306 W013589306
566-24-3-061 PISTON 566-20-7-251 COMPOSITE	1R12-531 	ASA-92-8-164 		

- Bolt or Stud – 1/2-13 or 1/2-20
- ⊗ Air Fitting – 1/4 NPTF
- ⊙ Stud – 3/4-10
- ⊕ Tapped Hole on Top Retainers – 3/8-16, on Pistons – 1/2-13
- ⊗ Air Fitting – 1/2 NPTF or 3/8 NPTF
- ⊙ Combination Stud Air Fitting: Stud – 3/4-16, Air Fitting – 1/4 NPTF

AIR SPRING ROLLING LOBES

AIR SPRING ROLLING LOBES

AIR SPRING ROLLING LOBES

BELLOWS NUMBER	SIDE VIEW WITH EXTENDED AND COMPRESSED HEIGHT	UPPER MOUNTING VIEW	LOWER MOUNTING VIEW	MANUFACTURER NUMBERS
566-24-3-061 PISTON 566-20-7-251 COMPOSITE	1R12-539 	ASA-92-8-164 		
566-24-3-066 PISTON 566-20-7-006 ALUMINUM	1R12-103 	ASA-92-8-164 		AUTOMANN AB1DK23L-9101 REYCO 12883-01 CONTI 9 10-19 P 315 64279 RIDEWELL 1003589101C S-5828-C S-740-C DAYTON 352-9101 TAURUS AS506-9093 AS509-9101 FIRESTONE 9101 W013589101 TOYO TRL-250 HENDRICKSON B-3842 TRIANGLE 8315 INT'L/ NAVISTAR 554768C1 TRP AS91010 LOAD GUARD SC2038 TRUCKSTELL 63647 NEWAY 900-44-701 905-57-008 905-57-009 905-57-082 WATSON & CHALIN AS-0040
566-24-3-066 PISTON NOT INCLUDED	1R12-113 	ASA-92-8-164 	USE EXISTING SUPER CUSHION PISTON	FIRESTONE W013589102 NEWAY 900-44-201 900-44-653 900-54-218 INT'L/ NAVISTAR 554769C1 RIDEWELL 1013589102C LOAD GUARD SC2053 TAURUS AS509-9102
566-24-3-066 PISTON 566-20-7-006 ALUMINUM	1R12-142 	ASA-92-8-005 		AUTOMANN AB1DK23L-9241 LOAD GUARD SC2108 CONTI 9 10-19 P 946 67479 SUSPENSIONS INC. 200041 FIRESTONE W013589241 INT'L/ NAVISTAR 1681579C1

- Bolt or Stud – 1/2-13 or 1/2-20
- ⊗ Air Fitting – 1/4 NPTF
- ⊙ Stud – 3/4-10
- ⊕ Tapped Hole on Top Retainers – 3/8-16, on Pistons – 1/2-13
- ⊗ Air Fitting – 1/2 NPTF or 3/8 NPTF
- ⊙ Combination Stud Air Fitting: Stud – 3/4-16, Air Fitting – 1/4 NPTF

BELLOWS NUMBER	SIDE VIEW WITH EXTENDED AND COMPRESSED HEIGHT	UPPER MOUNTING VIEW	LOWER MOUNTING VIEW	MANUFACTURER NUMBERS
566-24-3-066 PISTON 566-20-7-006 ALUMINUM	1R12-145 	ASA-92-8-017 		AUTOMANN AB1DK23L-9238 INT'L/ NAVISTAR 1681737C1 CONTI 9 10-19 P 356 64325 LOAD GUARD SC2109 DAYTON 352-9238 PREVOST 63-0178 FIRESTONE 9238 W013589238 TAURUS AS509-9238 TRIANGLE 8356 HENDRICKSON B-5060 TRP AS92380
566-24-3-066 PISTON 566-20-7-080 COMPOSITE	1R12-167 OBSOLETE 	ASA-92-8-164 		AUTOMANN AB1DK23L-9192 CONTI 9 10-19 P 326 64323 FIRESTONE 9192 INT'L/ NAVISTAR 1681738C1 1681740C1
566-24-3-066 PISTON 566-20-7-080 COMPOSITE	1R12-185 	ASA-92-8-164 		FIRESTONE 9192 W013589192 HENDRICKSON S6195
566-24-3-066 PISTON 566-20-7-006 ALUMINUM	1R12-195 	ASA-92-8-257 		AUTOMANN AB1DK23L-9349 REYCO 17636-01 CONTI 9 10-19 P 438 64335 TRIANGLE 8438 FIRESTONE 9349 W013589349 TRP AS93490 HENDRICKSON B-8988
566-24-3-066 PISTON 566-20-7-006 ALUMINUM	1R12-208 	ASA-92-8-141 		AUTOMANN AB1DK23L-P973 CONTI 9 10-19 P 973 67703 HENDRICKSON C-10443

- Bolt or Stud – 1/2-13 or 1/2-20
- ⊗ Air Fitting – 1/4 NPTF
- ⊙ Stud – 3/4-10
- ⊕ Tapped Hole on Top Retainers – 3/8-16, on Pistons – 1/2-13
- ⊗ Air Fitting – 1/2 NPTF or 3/8 NPTF
- ⊙ Combination Stud Air Fitting: Stud – 3/4-16, Air Fitting – 1/4 NPTF

AIR SPRING ROLLING LOBES

AIR SPRING ROLLING LOBES

AIR SPRING ROLLING LOBES

BELLOWS NUMBER	SIDE VIEW WITH EXTENDED AND COMPRESSED HEIGHT	UPPER MOUNTING VIEW	LOWER MOUNTING VIEW	MANUFACTURER NUMBERS
566-24-3-066 PISTON 566-20-7-006 ALUMINUM	1R12-261 	ASA-92-8-005 		CONTI 9 10-19 A 358 64327 DAYTON 352-9321 FIRESTONE 9241 W013589241 R&S TRUCK & BODY 10907 TAURUS AS509-9241 TRIANGLE 8358 8361
566-24-3-066 REPLACED BY 1R12-167 PISTON 566-20-7-080 COMPOSITE	1R12-265 OBSOLETE 	ASA-92-8-164 		CONTI 9 10-19 P 390 64331 FIRESTONE 9245
566-24-3-066 PISTON 566-20-7-080 COMPOSITE	1R12-281 	ASA-92-8-121 		AUTOMANN AB1DK23L-9130 AB1DK23L-9350 AB1DK23L-9394 AB1DK23L-P946 CONTI 9 10-19 A 358 64327 DAYTON 352-9130 FIRESTONE 9130 9394 FIRESTONE CONT. W013589130 W013589394 FRUEHAUF UCE-9393-1 UCE-9393-3 UCE-9393-4 TRIANGLE 8321 TRP AS91300
566-24-3-066 PISTON 566-20-7-006 ALUMINUM	1R12-357 OBSOLETE 	ASA-92-8-257 		AUTOMANN AB1DK23L-9348 CONTI 9 10-19 P 439 65356 FIRESTONE 9348 W103589348 TAURUS AS509-9348 TRP AS93480
566-24-3-066 PISTON 566-20-7-080 COMPOSITE	1R12-395 	ASA-92-8-005 		AUTOMANN AB1DK23L-9203 CONTI 9 10-19 P 355 64324 DAYTON 352-9203 FIRESTONE 9203 W013589203 HENDRICKSON B-2694 TAURUS AS509-9203 TRIANGLE 8355 TRP AS92030

- Bolt or Stud – 1/2-13 or 1/2-20
- ⊗ Tapped Hole on Top Retainers – 3/8-16, on Pistons – 1/2-13
- ⊗ Air Fitting – 1/4 NPTF
- ⊗ Air Fitting – 1/2 NPTF or 3/8 NPTF
- ⊙ Stud – 3/4-10
- ⊗ Combination Stud Air Fitting: Stud – 3/4-16, Air Fitting – 1/4 NPTF

BELLOWS NUMBER	SIDE VIEW WITH EXTENDED AND COMPRESSED HEIGHT	UPPER MOUNTING VIEW	LOWER MOUNTING VIEW	MANUFACTURER NUMBERS
566-24-3-066 PISTON 566-20-7-237 COMPOSITE	1R12-439 	ASA-92-8-164 		AUTOMANN AB1DK23L-9346 8470 CONTI 9 10-19 P 470 64338 FIRESTONE 9346 W013589346 NEWAY 905-57-126 TRIANGLE TRP AS93460 WATSON & CHALIN AS-0056
566-24-3-066 PISTON 566-20-7-159 COMPOSITE	1R12-444 	ASA-92-8-004 		AUTOMANN AB1R12-444
566-24-3-066 PISTON 566-20-7-005 ALUMINUM	1R12-467 	ASA-92-8-331 		AUTOMANN AB1DK23L-AB01 AB1DK23L-AB30 CONTI 9 10-19 P 801 65387 RIDEWELL 1000001 TRP AS24676 ASA8010
566-24-3-066 PISTON 566-20-7-235 COMPOSITE	1R12-480 	ASA-92-8-164 		AUTOMANN AB1DK23L-9243 CONTI 9 10-19 P 384 64329 FIRESTONE 9243 W013589243 NEWAY 905-57-112 TRP AS92430 WATSON & CHALIN AS-0061
566-24-3-066 PISTON 566-20-7-237 COMPOSITE	1R12-504 	ASA-92-8-269 		AUTOMANN AB1DK23P-9471 CONTI 9 10-17.5 P 502 64409 FIRESTONE 9471 W013589471 TRP AS94710

- Bolt or Stud – 1/2-13 or 1/2-20
- ⊗ Tapped Hole on Top Retainers – 3/8-16, on Pistons – 1/2-13
- ⊗ Air Fitting – 1/4 NPTF
- ⊗ Air Fitting – 1/2 NPTF or 3/8 NPTF
- ⊙ Stud – 3/4-10
- ⊗ Combination Stud Air Fitting: Stud – 3/4-16, Air Fitting – 1/4 NPTF

AIR SPRING ROLLING LOBES

AIR SPRING ROLLING LOBES

BELLOWS NUMBER	SIDE VIEW WITH EXTENDED AND COMPRESSED HEIGHT	UPPER MOUNTING VIEW	LOWER MOUNTING VIEW	MANUFACTURER NUMBERS
566-24-3-066 PISTON 566-20-7-006 ALUMINUM	1R12-527 	ASA-92-8-002 		
566-24-3-066 PISTON 566-20-7-235 COMPOSITE	1R12-568 	ASA-92-8-041 		AUTOMANN AB1DK23L-8852 CONTI 9 10-19 P 472 64339 FIRESTONE 8852 W013588852 FLEETRITE 1R12-1058 PETERBILT 03-07887 SPRINGRIDE 1R12-1081 TRIANGLE 8472 TRP AS88520
566-24-3-066 PISTON 566-20-7-158 COMPOSITE	1R12-607 	ASA-92-8-331 		
566-24-3-066 PISTON 566-20-7-158 COMPOSITE	1R12-613 	ASA-92-8-192 		AUTOMANN AB1DK23L-A552 CONTI 9 10-19 A 552 64761
566-24-3-066 PISTON 566-20-7-159 COMPOSITE	1R12-639 	ASA-92-8-164 		CONTI 910-19P357 64326 FIRESTONE W013589240

- Bolt or Stud – 1/2-13 or 1/2-20
- ⊗ Air Fitting – 1/4 NPTF
- ⊙ Stud – 3/4-10
- ⊕ Tapped Hole on Top Retainers – 3/8-16, on Pistons – 1/2-13
- ⊗ Air Fitting – 1/2 NPTF or 3/8 NPTF
- ⊙ Combination Stud Air Fitting: Stud – 3/4-16, Air Fitting – 1/4 NPTF

AIR SPRING ROLLING LOBES

BELLOWS NUMBER	SIDE VIEW WITH EXTENDED AND COMPRESSED HEIGHT	UPPER MOUNTING VIEW	LOWER MOUNTING VIEW	MANUFACTURER NUMBERS
566-24-3-066 PISTON 566-20-7-159 COMPOSITE	1R12-653 	ASA-92-8-004 		
566-24-3-066 PISTON 566-20-7-236 COMPOSITE	1R12-689 	ASA-92-8-344 		
566-24-3-067 PISTON 566-20-7-014 STEEL	1R12-095 	ASA-92-8-162 		AUTOMANN AB1DK23F-9039 BLUEBIRD 12TA-1-2 300-961250 CONTI 9 10-10 P 311 64260 DAYTON 352-9039 FAB TEK 101827 FIRESTONE 9039 W013589039 FLEETRITE 1R12-1061 FLXIBLE 6-336-202 HDA PMABG-9039B HENDRICKSON 8-11650 8-2064 HUTCHENS IND. 9424-01 9424-03 INT'L/NAVISTAR 554766C1 LOAD GUARD SC2033 NEWAY 905-57-011 905-57-023 905-57-085 R&S TRUCK & BODY 1090218 RIDEWELL 1003589039C 1013589039C SAUR AXLES P50-734 SPRINGRIDE 1R12-1061 SUSPENSIONS INC. 200457 TAURUS AS500-9039 TRIANGLE 8311 TRP AS90390 WATSON & CHALIN AS-0012
566-24-3-067 PISTON NOT INCLUDED	1R12-097 	ASA-92-8-162 	USE EXISTING SUPER CUSHION PISTON	HUTCHENS IND. 9424-1 INT'L/NAVISTAR 554767C1 LOAD GUARD SC2058 NEWAY 900-44-199 900-44-708 900-54-234 RIDEWELL 1013580702C TAURUS AS500-0702

- Bolt or Stud – 1/2-13 or 1/2-20
- ⊗ Air Fitting – 1/4 NPTF
- ⊙ Stud – 3/4-10
- ⊕ Tapped Hole on Top Retainers – 3/8-16, on Pistons – 1/2-13
- ⊗ Air Fitting – 1/2 NPTF or 3/8 NPTF
- ⊙ Combination Stud Air Fitting: Stud – 3/4-16, Air Fitting – 1/4 NPTF

AIR SPRING ROLLING LOBES

AIR SPRING ROLLING LOBES

BELLOWS NUMBER	SIDE VIEW WITH EXTENDED AND COMPRESSED HEIGHT	UPPER MOUNTING VIEW	LOWER MOUNTING VIEW	MANUFACTURER NUMBERS
566-24-3-067 PISTON 566-20-7-055 ALUMINUM	1R12-156 	ASA-92-8-005 		MCI 12K-3-11 PREVOST 63-0179
566-24-3-067 PISTON 566-20-7-055 ALUMINUM	1R12-178 	ASA-92-8-125 		CONTI 9 9-12 P 379 64361 FIRESTONE 9379 W013589379 INT'L/ NAVISTAR 1660694C1
566-24-3-067 PISTON 566-20-7-055 ALUMINUM	1R12-204 	ASA-92-8-138 		FIRESTONE 9566 W013589566 INT'L/ NAVISTAR 1672401C1
566-24-3-067 PISTON 566-20-7-164 STEEL	1R12-309 	ASA-92-8-002 		AUTOMANN AB1DK23H-9053 CONTI 9 10-12 A 327 64446 DAYTON 352-9053 E-Z RIDE 8030192 FAB TEK 10828 FIRESTONE 9053 W013589053
566-24-3-067 PISTON 566-20-7-055 ALUMINUM	1R12-324 	ASA-92-8-138 		FIRESTONE 9565 W013589565 INT'L/ NAVISTAR 2027912C1

- Bolt or Stud – 1/2-13 or 1/2-20
- ⊗ Air Fitting – 1/4 NPTF
- ⊙ Stud – 3/4-10
- ⊕ Tapped Hole on Top Retainers – 3/8-16, on Pistons – 1/2-13
- ⊗ Air Fitting – 1/2 NPTF or 3/8 NPTF
- ⊙ Combination Stud Air Fitting: Stud – 3/4-16, Air Fitting – 1/4 NPTF

AIR SPRING ROLLING LOBES

BELLOWS NUMBER	SIDE VIEW WITH EXTENDED AND COMPRESSED HEIGHT	UPPER MOUNTING VIEW	LOWER MOUNTING VIEW	MANUFACTURER NUMBERS
566-24-3-067 PISTON 566-20-7-014 STEEL	1R12-465 	ASA-92-8-013 		AUTOMANN AB1DK23F-8963 CONTI 9 10-10 P 473 64440 FIRESTONE W013588963
566-24-3-067 PISTON 566-20-7-239 COMPOSITE	1R12-487 	ASA-92-8-164 		AUTOMANN AB1DK23H-9366 CONTI 9 10-12 P 488 64459 FIRESTONE 9366 W013589366 NABI-HF 633-7773
566-24-3-067 PISTON 566-20-7-251 COMPOSITE	1R12-508 	ASA-92-8-164 		AUTOMANN AB1DK23F-9334 AB1DK23F-9307 AB1DK23H-8204 CONTI 9 10-10 P 471 64439 FIRESTONE 8204 W103588204 W013589307 W013589334
566-24-3-067 PISTON 566-20-7-253 COMPOSITE	1R12-555 	ASA-92-8-017 		AUTOMANN AB1DK23F-8961 CONTI 9 10-10 P 542 64658 FIRESTONE 8961 W013588961 REYCO 23377-01 TRIANGLE 8542
566-24-3-067 PISTON 566-20-7-252 COMPOSITE	1R12-556 	ASA-92-8-017 		AUTOMANN AB1DK23F-8964 CONTI 9 10-10 P 480 64441 FIRESTONE 8964 W013588964 REYCO 21598-01 TRIANGLE 8480

- Bolt or Stud – 1/2-13 or 1/2-20
- ⊗ Air Fitting – 1/4 NPTF
- ⊙ Stud – 3/4-10
- ⊕ Tapped Hole on Top Retainers – 3/8-16, on Pistons – 1/2-13
- ⊗ Air Fitting – 1/2 NPTF or 3/8 NPTF
- ⊙ Combination Stud Air Fitting: Stud – 3/4-16, Air Fitting – 1/4 NPTF

AIR SPRING ROLLING LOBES

AIR SPRING ROLLING LOBES

AIR SPRING ROLLING LOBES

BELLOWS NUMBER	SIDE VIEW WITH EXTENDED AND COMPRESSED HEIGHT	UPPER MOUNTING VIEW	LOWER MOUNTING VIEW	MANUFACTURER NUMBERS
566-24-3-067 PISTON 566-20-7-252 COMPOSITE	1R12-557 	ASA-92-8-017 		AUTOMANN AB1DK23F-8976 CONTI 9 10-10 P 503 64444 FIRESTONE 8976 W013588976 REYCO 21055-01 TRIANGLE 8503
566-24-3-067 PISTON 566-20-7-252 COMPOSITE	1R12-558 	ASA-92-8-164 		AUTOMANN AB1DK23F-8986 CONTI 9 10-10 P 400 64438 FIRESTONE 8986 W013588986 RIDEWELL 1003588986C TRIANGLE 8400
566-24-3-067 PISTON 566-20-7-252 COMPOSITE	1R12-559 	ASA-92-8-164 		AUTOMANN AB1DK23F-9029 CONTI 9 10-10 P 399 64437 FIRESTONE 9029 W013589029 RIDEWELL 1003589029C TRIANGLE 8399
566-24-3-067 PISTON 566-20-7-253 COMPOSITE	1R12-560 	ASA-92-8-164 		AUTOMANN AB1DK23F-9308 CONTI 9 10-10 P 398 64436 FIRESTONE 9308 W013589308 NEWAY 905-57-089 REYCO 17360-01 TRIANGLE 8398 TRP AS93080
566-24-3-067 PISTON 566-20-7-253 COMPOSITE	1R12-561 	ASA-92-8-164 		CONTI 910-10P397 64435 FIRESTONE 9332 W013589332 REYCO 20074-01 TRIANGLE 8397 TRP AS93320

- Bolt or Stud – 1/2-13 or 1/2-20
- ⊗ Air Fitting – 1/4 NPTF
- ⊙ Stud – 3/4-10
- ⊕ Tapped Hole on Top Retainers – 3/8-16, on Pistons – 1/2-13
- ⊗ Air Fitting – 1/2 NPTF or 3/8 NPTF
- ⊙ Combination Stud Air Fitting: Stud – 3/4-16, Air Fitting – 1/4 NPTF

BELLOWS NUMBER	SIDE VIEW WITH EXTENDED AND COMPRESSED HEIGHT	UPPER MOUNTING VIEW	LOWER MOUNTING VIEW	MANUFACTURER NUMBERS
566-24-3-067 PISTON 566-20-7-251 COMPOSITE	1R12-562 	ASA-92-8-331 		AUTOMANN AB1DK23H-8197 CONTI 9 10-12 P 024 68009 FIRESTONE 8197 W013588197 NEWAY 905-57-230
566-24-3-067 PISTON 566-20-7-252 COMPOSITE	1R12-563 	ASA-92-8-192 		AUTOMANN AB1DK23H-8934 AB1DK23H-8934 AB1DK23H-8934 AB1DK23H-8934 AB1DK23H-8934 AB1DK23H-8934 AB1DK23H-8934 FIRESTONE 8934 W013588934 HENDRICKSON S-20228 TRIANGLE 8544 CONTI 9 10-12 P 544 64463
566-24-3-067 PISTON 566-20-7-238 COMPOSITE	1R12-571 	ASA-92-8-164 		AUTOMANN AB1DK23H-9365 CONTI 9 10-12 P 495 64460 FIRESTONE 9365 W013589365 NEWAY 905-57-159 TRIANGLE 8495 TRP AS93650
566-24-3-072 PISTON 566-20-7-079 STEEL	1R12-212 	UPPER BEAD PLATE NOT INCLUDED.		MCI G1004846
566-24-3-076 PISTON 566-20-7-036 ALUMINUM	1R12-076 	ASA-92-8-151 		AM GENERAL 5973924 597324 FIRESTONE 9100 W013589100

- Bolt or Stud – 1/2-13 or 1/2-20
- ⊗ Air Fitting – 1/4 NPTF
- ⊙ Stud – 3/4-10
- ⊕ Tapped Hole on Top Retainers – 3/8-16, on Pistons – 1/2-13
- ⊗ Air Fitting – 1/2 NPTF or 3/8 NPTF
- ⊙ Combination Stud Air Fitting: Stud – 3/4-16, Air Fitting – 1/4 NPTF

AIR SPRING ROLLING LOBES

AIR SPRING ROLLING LOBES

AIR SPRING ROLLING LOBES

BELLOWS NUMBER	SIDE VIEW WITH EXTENDED AND COMPRESSED HEIGHT	UPPER MOUNTING VIEW	LOWER MOUNTING VIEW	MANUFACTURER NUMBERS
566-24-3-076 PISTON 566-20-7-036 ALUMINUM	1R12-132 	ASA-92-8-164 		AUTOMANN AB1DK23H-9105 AB1DK23H-9113 AB1DK23H-9302 CONTI 9 10-12 P 319 64445 DAYTON 352-9105 FIRESTONE 9105 9113 9302 9303 W013589105 W013589302 GRANNING 5065 HDA PMABG-9105B HENDRICKSON 36514-3 B-1245 INT'L/NAVISTAR 554770C1 LOAD GUARD SC2039 R&S TRUCK & BODY 1090276 RIDEWELL 1003580725C 1003589105C S-570-C SAUR AXLES P50-705 TAURUS AS302-9302 AS502-0725 AS502-9105 AS502-9113 TRIANGLE 8319 TRP AS93020 WATSON & CHALIN AS-0015
566-24-3-076 PISTON 566-20-7-006 ALUMINUM	1R12-139 	ASA-92-8-098 		MCI 121-1-23
566-24-3-076 PISTON 566-20-7-036-03 ALUMINUM	1R12-169 	ASA-92-8-119 		FLXIBLE 97-2410-00006 97-2410-1 97-2410-2 97-2410-3 97-2410-4 97-2410-5 97-6693-1
566-24-3-076 PISTON 566-20-7-055 ALUMINUM	1R12-205 	ASA-92-8-125 		AUTOMANN AB1DK231-9568 CONTI 9 10-14 P 450 64472 FIRESTONE 9568 W013589568 INT'L/NAVISTAR 1675495C1 TRIANGLE 8450 TRP AS95680

- Bolt or Stud – 1/2-13 or 1/2-20
- ⊗ Air Fitting – 1/4 NPTF
- ⊙ Stud – 3/4-10
- ⊕ Tapped Hole on Top Retainers – 3/8-16, on Pistons – 1/2-13
- ⊗ Air Fitting – 1/2 NPTF or 3/8 NPTF
- ⊙ Combination Stud Air Fitting: Stud – 3/4-16, Air Fitting – 1/4 NPTF

BELLOWS NUMBER	SIDE VIEW WITH EXTENDED AND COMPRESSED HEIGHT	UPPER MOUNTING VIEW	LOWER MOUNTING VIEW	MANUFACTURER NUMBERS
566-24-3-076 PISTON 566-20-7-055 ALUMINUM	1R12-325 	ASA-92-8-125 		AUTOMANN AB1DK231-9567 CONTI 9 10-14 P 461 64473 FIRESTONE 9567 W013589567 INT'L/NAVISTAR 2027913C1 TRIANGLE 8461 TRP AS95670
566-24-3-076 PISTON 566-20-7-080 COMPOSITE	1R12-352 	ASA-92-8-004 		AUTOMANN AB1DK231-9010 CONTI 9 10-14 P 345 64258 FIRESTONE W013589010 HENDRICKSON B-2827 TRP AS90100
566-24-3-076 PISTON 566-20-7-036 ALUMINUM	1R12-355 	ASA-92-8-088 		AUTOMANN AB1DK23H-9078 CONTI 9 10-12 P 329 64447 FIRESTONE 9078 W013589078 FRUEHAUF MFR-022355 UCB-9668-1 TRIANGLE 8329
566-24-3-076 PISTON 566-20-7-164 STEEL	1R12-367 	ASC-92-8-192 		AUTOMANN AB1DK23H-9640 CONTI 9 10-12 A 427 64395 FIRESTONE 9640 W013589640 HENDRICKSON C-20223 TRIANGLE 8427 TRP AS96400
566-24-3-076 PISTON 566-20-7-036 ALUMINUM	1R12-370 	ASA-92-8-162 		AUTOMANN AB1DK231-9070 CONTI 9 10-14 A 330 64464 FIRESTONE 9070 W013589070 NEWAY 905-57-038-1 905-57-090 AR-90112 TAURUS AS504-9070 TRIANGLE 8330 8490 TRP AS90700 WATSON & CHALIN AS-0050 AS-0053

- Bolt or Stud – 1/2-13 or 1/2-20
- ⊗ Air Fitting – 1/4 NPTF
- ⊙ Stud – 3/4-10
- ⊕ Tapped Hole on Top Retainers – 3/8-16, on Pistons – 1/2-13
- ⊗ Air Fitting – 1/2 NPTF or 3/8 NPTF
- ⊙ Combination Stud Air Fitting: Stud – 3/4-16, Air Fitting – 1/4 NPTF

AIR SPRING ROLLING LOBES

AIR SPRING ROLLING LOBES

AIR SPRING ROLLING LOBES

BELLOWS NUMBER	SIDE VIEW WITH EXTENDED AND COMPRESSED HEIGHT	UPPER MOUNTING VIEW	LOWER MOUNTING VIEW	MANUFACTURER NUMBERS
566-24-3-076 PISTON 566-20-7-164 STEEL	1R12-434 	ASA-92-8-164 		AUTOMANN AB1DK231-8802 CONTI 9 10-14 P 469 64477 FIRESTONE 8802 W013588802 NEWAY 905-57-170 RIDEWELL 1003588802C TRIANGLE 8469 TRP AS88020
566-24-3-076 PISTON 566-20-7-156 COMPOSITE	1R12-437 	ASA-92-8-017 		AUTOMANN AB1DK231-9797 CONTI 9 10-14 A 496 64484 FIRESTONE 9797 W013589797 RIDEWELL 1003589797C TRIANGLE 8496 TRP AS97970
566-24-3-076 PISTON 566-20-7-156 COMPOSITE	1R12-445 	ASA-92-8-164 		AUTOMANN AB1DK231-8806 CONTI 9 10-14 A 545 64486 FIRESTONE 8806 W013588806 RIDEWELL 1003588802X
566-24-3-076 PISTON 566-20-7-036 ALUMINUM	1R12-492 	ASA-92-8-164 		CONTI 9 10-14 A 545 64486 FIRESTONE W013588806
566-24-3-076 PISTON 566-20-7-235 COMPOSITE	1R12-505 	ASA-92-8-164 		AUTOMANN AB1DK23H-9325 CONTI 9 10-12 P 395 64451 FIRESTONE 9325 W013589325 GILLIG 87-17289 NABI-HF 630-5056 NEWAY 905-57-149 TRIANGLE 8395 TRP AS93250

- Bolt or Stud – 1/2-13 or 1/2-20
- ⊗ Air Fitting – 1/4 NPTF
- ⊙ Stud – 3/4-10
- ⊕ Tapped Hole on Top Retainers – 3/8-16, on Pistons – 1/2-13
- ⊗ Air Fitting – 1/2 NPTF or 3/8 NPTF
- ⊙ Combination Stud Air Fitting: Stud – 3/4-16, Air Fitting – 1/4 NPTF

BELLOWS NUMBER	SIDE VIEW WITH EXTENDED AND COMPRESSED HEIGHT	UPPER MOUNTING VIEW	LOWER MOUNTING VIEW	MANUFACTURER NUMBERS
566-24-3-076 PISTON 566-20-7-156 COMPOSITE	1R12-512 	ASA-92-8-005 		AUTOMANN AB1DK23H-9127A CONTI 9 10-12 A 707 64633 FIRESTONE 9127 W013589127 NEW FLYER 9594
566-24-3-076 PISTON 566-20-7-212 COMPOSITE	1R12-543 	ASA-92-8-269 		CONTI 9 10-14 A 575 65361 NEWAY 905-57-275
566-24-3-076 PISTON 566-20-7-156 COMPOSITE	1R12-600 	ASA-92-8-331 		
566-24-3-076 PISTON 566-20-7-156 COMPOSITE	1R12-614 	ASA-92-8-164 		
566-24-3-076 PISTON 566-20-7-251 COMPOSITE	1R12-616 	ASA-92-8-164 		

- Bolt or Stud – 1/2-13 or 1/2-20
- ⊗ Air Fitting – 1/4 NPTF
- ⊙ Stud – 3/4-10
- ⊕ Tapped Hole on Top Retainers – 3/8-16, on Pistons – 1/2-13
- ⊗ Air Fitting – 1/2 NPTF or 3/8 NPTF
- ⊙ Combination Stud Air Fitting: Stud – 3/4-16, Air Fitting – 1/4 NPTF

AIR SPRING ROLLING LOBES

AIR SPRING ROLLING LOBES

AIR SPRING ROLLING LOBES

BELLOWS NUMBER	SIDE VIEW WITH EXTENDED AND COMPRESSED HEIGHT	UPPER MOUNTING VIEW	LOWER MOUNTING VIEW	MANUFACTURER NUMBERS
566-24-3-076 PISTON 566-20-7-239 COMPOSITE	1R12-620 	ASA-92-8-430 		AUTOMANN AB1DK231-9335 CONTI 9 10-14 P 465 64475 FIRESTONE 9335 W013589335 HENDRICKSON 56917-1 56917-2 65086-2 TRIANGLE 8465 TRP AS93350
566-24-3-076 PISTON 566-20-7-156 COMPOSITE	1R12-636 	ASA-92-8-440 		AUTOMANN AB1DK231-9634 CONTI 9 10-14 A 575 65361 FIRESTONE 9634 W013589634 TRP AS96340
566-24-3-076 PISTON 566-20-7-239 COMPOSITE	1R12-648 	ASA-92-8-164 		AUTOMANN AB1DK231-9336 CONTI 9 10-14 P 490 64479 FIRESTONE 9336 W013589336
566-24-3-076 PISTON 566-20-7-158 COMPOSITE	1R12-655 	ASA-92-8-164 		
566-24-3-076 PISTON 566-20-7-235 COMPOSITE	1R12-676 	ASA-92-8-041 		CONTI 9 10-14 P 312 64274 FIRESTONE 9069 W013589069



- Bolt or Stud – 1/2-13 or 1/2-20
- ⊗ Air Fitting – 1/4 NPTF
- ⊙ Stud – 3/4-10
- ⊕ Tapped Hole on Top Retainers – 3/8-16, on Pistons – 1/2-13
- ⊗ Air Fitting – 1/2 NPTF or 3/8 NPTF
- ⊙ Combination Stud Air Fitting: Stud – 3/4-16, Air Fitting – 1/4 NPTF

BELLOWS NUMBER	SIDE VIEW WITH EXTENDED AND COMPRESSED HEIGHT	UPPER MOUNTING VIEW	LOWER MOUNTING VIEW	MANUFACTURER NUMBERS
566-24-3-079 PISTON 566-20-7-079 STEEL	1R12-631 	ASA-92-8-439 		PREVOST 360258 63-0125
566-24-3-080 PISTON 566-20-7-080 COMPOSITE	1R12-645 	ASA-92-8-164 		FIRESTONE W013589210
566-24-3-090 PISTON 566-20-7-159 COMPOSITE	1R12-256 	ASA-92-8-142 		AUTOMANN AB1DK23N-9367 CONTI 9 10-21 P 505 64384 FIRESTONE 9367 W013589321 W013589367 HENDRICKSON B-14249 B-4375 LOAD GUARD SC2120 SPRINGRIDE 1R12-1071 SUSPENSIONS INC. 201335 TRIANGLE 8505 TRP AS93670 AS9367A WATSON & CHALIN AS-0104
566-24-3-090 PISTON 566-20-7-006 ALUMINUM	1R12-335 	ASA-92-8-142 		AUTOMANN AB1DK23N-9321 AB1DK23N-9367A CONTI 9 10-21 P 361 64291 FIRESTONE 9321 W013589321 TRP AS93210 WATSON & CHALIN AS-0036
566-24-3-090 PISTON 566-20-7-159 COMPOSITE	1R12-363 	ASA-92-8-164 		AUTOMANN AB1DK23N-9320 CONTI 9 10-21 P 360 64382 FIRESTONE 9320 W013589320 NEWAY 905-57-099 TRIANGLE 8360 TRP AS93200

- Bolt or Stud – 1/2-13 or 1/2-20
- ⊗ Air Fitting – 1/4 NPTF
- ⊙ Stud – 3/4-10
- ⊕ Tapped Hole on Top Retainers – 3/8-16, on Pistons – 1/2-13
- ⊗ Air Fitting – 1/2 NPTF or 3/8 NPTF
- ⊙ Combination Stud Air Fitting: Stud – 3/4-16, Air Fitting – 1/4 NPTF

AIR SPRING ROLLING LOBES

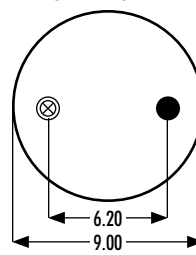
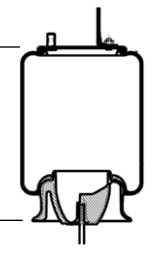
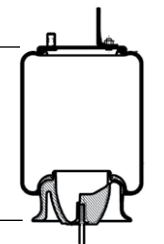
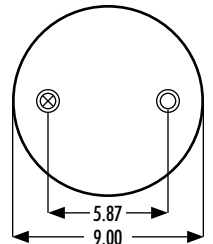
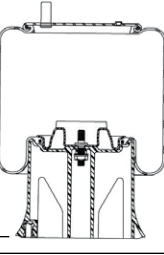
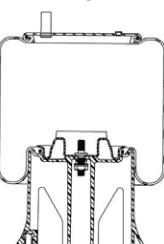
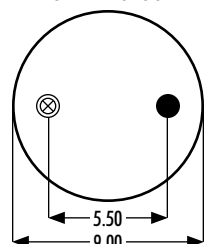
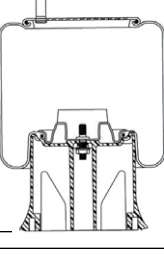
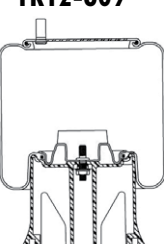
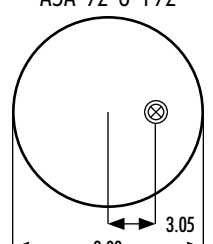
AIR SPRING ROLLING LOBES

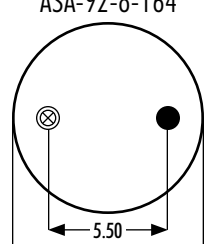
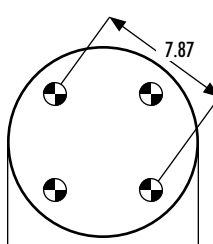
BELLOWS NUMBER	SIDE VIEW WITH EXTENDED AND COMPRESSED HEIGHT	UPPER MOUNTING VIEW	LOWER MOUNTING VIEW	MANUFACTURER NUMBERS
566-24-3-090 PISTON 566-20-7-237	1R12-440 	ASA-92-8-142 	566-20-7-237 	FIRESTONE W013589370
566-24-3-090 PISTON 566-20-7-236 COMPOSITE	1R12-507 	ASA-92-8-355 	M12 x 1.75-6G 	
566-24-3-090 PISTON 566-20-7-159 COMPOSITE	1R12-599 	ASA-92-8-331 		
566-24-3-090 PISTON 566-20-7-159 COMPOSITE	1R12-609 	ASA-92-8-192 		CONTI 910-21P817 65649
566-24-3-090 PISTON 566-20-7-159 COMPOSITE	1R12-637 	ASA-92-8-164 		AUTOMANN AB1DK23N-9338 CONTI 9 10-21 P 511 64385 FIRESTONE W013589338

- Bolt or Stud – 1/2-13 or 1/2-20
- ⊗ Air Fitting – 1/4 NPTF
- ⊙ Stud – 3/4-10
- ⊕ Tapped Hole on Top Retainers – 3/8-16, on Pistons – 1/2-13
- ⊗ Air Fitting – 1/2 NPTF or 3/8 NPTF
- ⊙ Combination Stud Air Fitting: Stud – 3/4-16, Air Fitting – 1/4 NPTF

AIR SPRING ROLLING LOBES

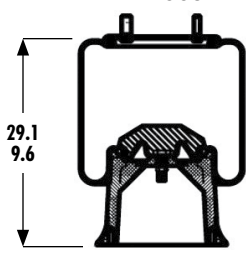
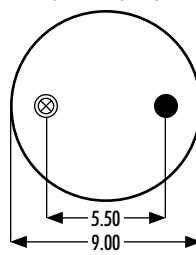
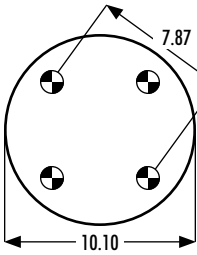
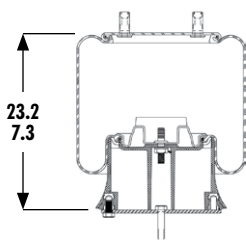
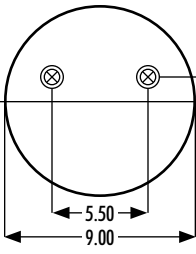
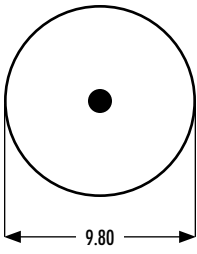
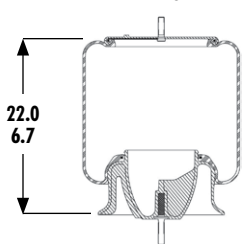
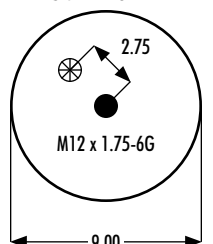
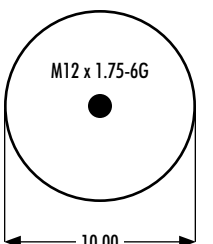
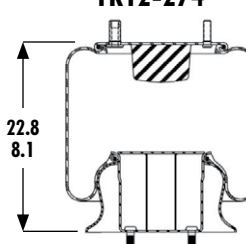
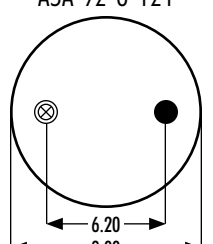
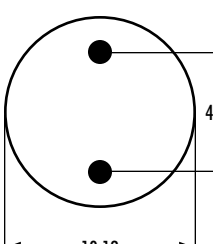
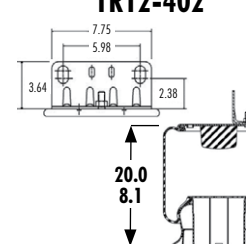
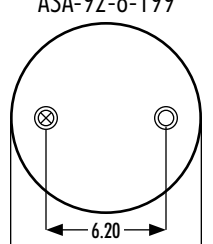
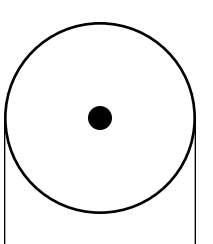
BELLOWS NUMBER	SIDE VIEW WITH EXTENDED AND COMPRESSED HEIGHT	UPPER MOUNTING VIEW	LOWER MOUNTING VIEW	MANUFACTURER NUMBERS
566-24-3-090 PISTON 566-20-7-006 ALUMINUM	1R12-663 	ASA-92-8-164 		CONTI 9 10-21 P 360 64382 FIRESTONE W013589320
566-24-3-097 PISTON 566-20-7-158 COMPOSITE	1R12-1048 	ASA-92-8-238 		AUTOMANN AB1DK23P-9974 CONTI 9 10-17.5 A 930 67586 FIRESTONE 9974 W013589974 TRP AS99740
566-24-3-097 PISTON 566-20-7-236 COMPOSITE	1R12-1049 	ASC-92-8-471 	M12 x 1.75-6G 	MACK TRUCK 21244322 21669088 VOLVO 21669088
566-24-3-097 PISTON 566-20-7-079 STEEL	1R12-274 	ASA-92-8-121 		
566-24-3-097 PISTON 566-20-7-246 STEEL	1R12-402 	ASA-92-8-199 		AUTOMANN AB1DK23M-9297 CONTI 9 10-18.5 P 520 64410 FIRESTONE 9297 W013589297 HENDRICKSON 50898-1 50898-2

- Bolt or Stud – 1/2-13 or 1/2-20
- ⊗ Air Fitting – 1/4 NPTF
- ⊙ Stud – 3/4-10
- ⊕ Tapped Hole on Top Retainers – 3/8-16, on Pistons – 1/2-13
- ⊗ Air Fitting – 1/2 NPTF or 3/8 NPTF
- ⊙ Combination Stud Air Fitting: Stud – 3/4-16, Air Fitting – 1/4 NPTF

AIR SPRING ROLLING LOBES

AIR SPRING ROLLING LOBES

AIR SPRING ROLLING LOBES

BELLOWS NUMBER	SIDE VIEW WITH EXTENDED AND COMPRESSED HEIGHT	UPPER MOUNTING VIEW	LOWER MOUNTING VIEW	MANUFACTURER NUMBERS	
566-24-3-097 PISTON 566-20-7-246 STEEL	1R12-404 	ASA-92-8-430 		AUTOMANN AB1DK23M-9375 CONTI 9 10-18.5 P 451 64264 FIRESTONE 9375 W013589375 FLEETRITE 1R12-1063 50899-2	HENDRICKSON 50899-1 MACK TRUCK 3645Q27 57QL414M SPRINGRIDE 1R12-1076 TRIANGLE 8451 TRP AS93750
566-24-3-097 PISTON 566-20-7-246 STEEL	1R12-424 	ASA-92-8-199 		AUTOMANN AB1DK23M-9287 CONTI 9 10-18.5 P 406 64277 FIRESTONE 9287 W013589287 GMC 15963160	HENDRICKSON 50405 50405-1 50405-2 TRIANGLE 8406 TRP AS92870
566-24-3-097 PISTON 566-20-7-158 COMPOSITE	1R12-446 	ASA-92-8-164 		AUTOMANN AB1DK23L-9245 CONTI 9 10-19 P 390 64331 FIRESTONE 9245 W013589245 RIDEWELL 1003589245C	TRIANGLE 8390 TRP AS92450
566-24-3-097 PISTON 566-20-7-158 COMPOSITE	1R12-450 	ASA-92-8-164 		AUTOMANN AB1DK23P-9342 CONTI 9 10-17.5 P 418 64334 FIRESTONE W013589342	
566-24-3-097 PISTON 566-20-7-235 COMPOSITE	1R12-481 	ASA-92-8-164 		AUTOMANN AB1DK23P-9923 CONTI 9 10-17.5 P 429 64278 FIRESTONE 9923 W013589923 NEWAY 905-57-118	TRIANGLE 8429 TRP AS99230

- Bolt or Stud – 1/2-13 or 1/2-20
- ⊗ Air Fitting – 1/4 NPTF
- ⊙ Stud – 3/4-10
- ⊕ Tapped Hole on Top Retainers – 3/8-16, on Pistons – 1/2-13
- ⊗ Air Fitting – 1/2 NPTF or 3/8 NPTF
- ⊙ Combination Stud Air Fitting: Stud – 3/4-16, Air Fitting – 1/4 NPTF

BELLOWS NUMBER	SIDE VIEW WITH EXTENDED AND COMPRESSED HEIGHT	UPPER MOUNTING VIEW	LOWER MOUNTING VIEW	MANUFACTURER NUMBERS	
566-24-3-097 PISTON 566-20-7-237 COMPOSITE	1R12-498 	ASA-92-8-164 		AUTOMANN AB1DK23P-9922 CONTI 9 10-17.5 P 428 64399 FIRESTONE 9922 W013589922 NEWAY 905-57-119	TRIANGLE 8428 TRP AS99220
566-24-3-097 PISTON 566-20-7-235 COMPOSITE	1R12-532 	ASA-92-8-331 		AUTOMANN AB1DK23P-9935 CONTI 9 10-17.5 P 548 64412 FIRESTONE 9935 W013589935 NEWAY 905-57-157	TRIANGLE 8548 TRP AS99350
566-24-3-097	1R12-533				
566-24-3-097 PISTON 566-20-7-158 COMPOSITE	1R12-592 	ASA-92-8-355 			
566-24-3-097 PISTON 566-20-7-159 COMPOSITE	1R12-621 	ASA-92-8-164 		AUTOMANN AB1DK23K-9093 CONTI 9 10-16 P 332 64293 FIRESTONE 9093 W013589093	NEWAY 905-57-007 905-57-032 905-57-035 TRIANGLE 8332

- Bolt or Stud – 1/2-13 or 1/2-20
- ⊗ Air Fitting – 1/4 NPTF
- ⊙ Stud – 3/4-10
- ⊕ Tapped Hole on Top Retainers – 3/8-16, on Pistons – 1/2-13
- ⊗ Air Fitting – 1/2 NPTF or 3/8 NPTF
- ⊙ Combination Stud Air Fitting: Stud – 3/4-16, Air Fitting – 1/4 NPTF

AIR SPRING ROLLING LOBES

AIR SPRING ROLLING LOBES

AIR SPRING ROLLING LOBES

BELLOWS NUMBER	SIDE VIEW WITH EXTENDED AND COMPRESSED HEIGHT	UPPER MOUNTING VIEW	LOWER MOUNTING VIEW	MANUFACTURER NUMBERS
566-24-3-097 PISTON 566-20-7-236 COMPOSITE	1R12-622 	ASA-92-8-355 	 M12 x 1.75-6G	INT'L/ NAVISTAR 3596112C1
566-24-3-097 PISTON 566-20-7-158 COMPOSITE	1R12-644 	AS1-92-8-192 		AUTOMANN AB1DK23L-8855 CONTI 9 10-19 P 552 64340 FIRESTONE W013588855 TRP AS88550
566-24-3-097 PISTON 566-20-7-303 COMPOSITE	1R12-647 	ASA-92-8-546 	 M12 x 1.75-6G	MACK TRUCK 20910892 57QLS19M VOLVO 20733034
566-24-3-100 PISTON 566-20-7-036 ALUMINUM	1R12-593 	ASA-92-8-164 	 7.87	
566-24-3-108 PISTON 566-20-7-116 COMPOSITE	1R12-303 	ASA-92-8-440 		AUTOMANN AB1DF23-9780 CONTI 9 10S-16 P 382 67473 FIRESTONE 5779 9780 W013589780 FLEETRITE 1R12-1054 FREIGHTLINER 16-13810-000 16-13810-001 16-13810-002 16-14377-000 FREIGHTLINER (CONTI) 16-15595-000 16-15595-001 16-15595-002 16-16825-000 16-19468-000 18-18335-000 18-18335-001 18-18335-002 SPRINGRIDE 1R12-1072 TRIANGLE 8382 TRP AS9780P

- Bolt or Stud – 1/2-13 or 1/2-20
- ⊗ Air Fitting – 1/4 NPTF
- ⊙ Stud – 3/4-10
- ⊕ Tapped Hole on Top Retainers – 3/8-16, on Pistons – 1/2-13
- ⊗ Air Fitting – 1/2 NPTF or 3/8 NPTF
- ⊙ Combination Stud Air Fitting: Stud – 3/4-16, Air Fitting – 1/4 NPTF

BELLOWS NUMBER	SIDE VIEW WITH EXTENDED AND COMPRESSED HEIGHT	UPPER MOUNTING VIEW	LOWER MOUNTING VIEW	MANUFACTURER NUMBERS
566-24-3-108 PISTON 566-20-7-322 ALUMINUM	1R12-603 	ASA-92-8-440 		AUTOMANN AB1DF23-9781 CONTI 9 10-16 A 382 64266 FIRESTONE 9781 W013589781 FLEETRITE 1R12-1064 FREIGHTLINER 16-19465-000 6813200017 A16-14004-000 A16-14004-001 SPRINGRIDE 1R12-1082 TRIANGLE 8382 TRP AS9780A
566-24-3-116 PISTON 566-20-7-158 COMPOSITE	1R12-534 	ASA-92-8-360 	 7.87	CONTI 910-19P762 64708
566-24-3-116 PISTON 566-20-7-209 COMPOSITE	1R12-540 	ASA-92-8-360 	 7.87	WATSON & CHALIN AS-01146
566-24-3-117 PISTON 566-20-7-299 COMPOSITE	1R12-580 	ASA-92-8-367 		CONTI 910-21P448 64383 FIRESTONE 9370 W013589370 TRP AS93700 WATSON & CHALIN AS-0057
566-24-3-120 PISTON 566-20-7-192 STEEL	1R12-377 	ASA-92-8-268 	 4.12	PREVOST 63-0151

- Bolt or Stud – 1/2-13 or 1/2-20
- ⊗ Air Fitting – 1/4 NPTF
- ⊙ Stud – 3/4-10
- ⊕ Tapped Hole on Top Retainers – 3/8-16, on Pistons – 1/2-13
- ⊗ Air Fitting – 1/2 NPTF or 3/8 NPTF
- ⊙ Combination Stud Air Fitting: Stud – 3/4-16, Air Fitting – 1/4 NPTF

AIR SPRING ROLLING LOBES

AIR SPRING ROLLING LOBES

AIR SPRING ROLLING LOBES

BELLOWS NUMBER	SIDE VIEW WITH EXTENDED AND COMPRESSED HEIGHT	UPPER MOUNTING VIEW	LOWER MOUNTING VIEW	MANUFACTURER NUMBERS
566-24-3-140 PISTON 566-20-7-377 STEEL	1R12-403 	ASA-92-8-430 		AUTOMANN AB1DK23M-9373 HENDRICKSON 57122-1 CONTI 9 10-18.5 P 519 64265 MCI 2992101C1 FIRESTONE 9373 W013589373 SPRINGRIDE 1R12-1075 TRIANGLE 8519 FLEETRITE 1R12-1056 TRP AS93730
566-24-3-142 PISTON 566-20-7-413 COMPOSITE	1R12-1047 	ASA-92-8-547 		AUTOMANN AB1DK23I-9807 HENDRICKSON 57122-1 CONTI 9 10-13.5 P 874 68151 MCI 2992101C1 FIRESTONE 9807 W013589807 SPRINGRIDE 1R12-1074 TRIANGLE 8519 NEW HOLLAND 48100494 FLEETRITE 1R12-1056 TRP AS98070
566-24-3-161 PISTON 566-20-7-424	1R12-1094 	ASA-92-8-164 	566-20-7-424 	AUTOMANN AB1DK23H-8203 HENDRICKSON 57122-1 CONTI 9 10-12 P 543 MCI 2992101C1 FIRESTONE W01-358-8203 SPRINGRIDE 1R12-1075 TRIANGLE 8519 GILLIG 82-19159-000
566-24-3-163 PISTON 566-20-7-080 COMPOSITE	1R12-092 	ASA-92-8-164 		AUTOMANN AB1DK23K-9082 HENDRICKSON 57122-1 CONTI 9 10-16 P 310 64269 MCI 2992101C1 DAYTON 352-9082 AR-1315-1-F AR-1315-1-G FAB TEK 101828 NOVABUS N39112 FIRESTONE 9082 W013589082 R&S TRUCK & BODY 1090217 FLEETRITE 1R12-1053 REYCO 12882-01 GRANNING 2727 RIDEWELL 10035839082C 5-542-C HDA PMABG-9082B SPRINGRIDE 1R12-1070 HENDRICKSON 36514-7 B-2066 SUSPENSIONS INC. 201869 HUTCHENS IND. 9630-01 TAURUS AS506-9082 INT'L/NAVISTAR 517559C9 TOYO TRL-240/393 KWIK-LOK/TODCO CP-3281 CP-5125 CP5152 TRIANGLE 8310 LOAD GUARD SC2035 TRP AS90820 WATSON & CHALIN AS-0011

- Bolt or Stud – 1/2-13 or 1/2-20
- ⊗ Air Fitting – 1/4 NPTF
- ⊙ Stud – 3/4-10
- ⊕ Tapped Hole on Top Retainers – 3/8-16, on Pistons – 1/2-13
- ⊗ Air Fitting – 1/2 NPTF or 3/8 NPTF
- ⊙ Combination Stud Air Fitting: Stud – 3/4-16, Air Fitting – 1/4 NPTF

BELLOWS NUMBER	SIDE VIEW WITH EXTENDED AND COMPRESSED HEIGHT	UPPER MOUNTING VIEW	LOWER MOUNTING VIEW	MANUFACTURER NUMBERS
566-24-3-163 PISTON 566-20-7-221 COMPOSITE	1R12-401 	ASA-92-8-165 		CONTI 910-18-5P521 64290 INT'L/NAVISTAR 1670043C1 1686386C1 FIRESTONE 9371 W013589371 SPRINGRIDE 1R12-1074 FLEETRITE 1R12-1062 TRIANGLE 8521 TRP AS93710
566-24-3-163 PISTON 566-20-7-236 COMPOSITE	1R12-538 	ASA-92-8-165 		AUTOMANN AB1DK23M-9648 INT'L/NAVISTAR 2027911C1 2027911C2 2027911C3 CONTI 9 10-18.5 P 456 64263 SPRINGRIDE 1R12-1080 FIRESTONE 9648 W013589648 TRIANGLE 8456 FLEETRITE 1R12-1057 TRP AS96480
566-24-3-164 PISTON 566-20-7-303 COMPOSITE	1R12-615 	ASA-92-8-546 		AUTOMANN AB1DF23H-P1154 TRIANGLE 8449 CONTI 910-16P449 64312 TRP AS88290 FIRESTONE 8829 W013588829 VOLVO 20396293 20413888 20505399 FLEETRITE 1R12-1059 SPRINGRIDE 3934699 8079902 8084296 8097092 MACK TRUCK 57QL54M SPRINGRIDE 1R12-1083
566-24-3-165 PISTON 566-20-7-163 STEEL	1R12-375 	ASA-92-8-192 		AUTOMANN AB1DK23L-9265 HENDRICKSON 20413 C-20124 CONTI 9 10-19 P 435 64288 SPRINGRIDE 1R12-1073 FIRESTONE 9265 W013589265 TRIANGLE 8435 FLEETRITE 1R12-1055 TRP AS92650
566-24-3-165 PISTON 566-20-7-236 COMPOSITE	1R12-432 	ASA-92-8-344 		AUTOMANN AB1DK23R-1731 HENDRICKSON 20413 C-20124 CONTI 9 10B-19.5 P 889 66908 INT'L/NAVISTAR 350243C94 SPRINGRIDE 1R12-1077 FIRESTONE 9265 W013589265 TRIANGLE 8435 FLEETRITE 1R12-1055 TRP AS92650

- Bolt or Stud – 1/2-13 or 1/2-20
- ⊗ Air Fitting – 1/4 NPTF
- ⊙ Stud – 3/4-10
- ⊕ Tapped Hole on Top Retainers – 3/8-16, on Pistons – 1/2-13
- ⊗ Air Fitting – 1/2 NPTF or 3/8 NPTF
- ⊙ Combination Stud Air Fitting: Stud – 3/4-16, Air Fitting – 1/4 NPTF

AIR SPRING ROLLING LOBES

AIR SPRING ROLLING LOBES

AIR SPRING ROLLING LOBES

BELLOWS NUMBER	SIDE VIEW WITH EXTENDED AND COMPRESSED HEIGHT	UPPER MOUNTING VIEW	LOWER MOUNTING VIEW	MANUFACTURER NUMBERS
566-24-3-165 PISTON 566-20-7-236 COMPOSITE	1R12-523 	ASA-92-8-355 	M12 x 1.75-6G 	AUTOMANN AB1DK23R-9876 CONTI 9 10B-19.5 P 171 69310 INT'L/NAVISTAR 3541732C1 SPRINGRIDE 1R12-1079
566-24-3-170 PISTON 566-20-7-426 COMPOSITE	1R12-1093 	578-92-8-560 	566-20-7-426 	AUTOMANN AB1DK23M-9663 CONTI 9 10-18.5 P 939 67573 FIRESTONE W01-358-9663 HENDRICKSON 60271-2
566-24-3-171 PISTON 566-20-7-425	1R12-1095 	578-92-8-561 	566-20-7-425 	AUTOMANN AB1DK23I-9697 CONTI 9 10-14 P 882 FIRESTONE W01-358-9697 HOLLAND 90557329
566-24-3-172 PISTON 566-20-7-428	1R12-1097 	ASA-92-8-041 	566-20-7-428 	AUTOMANN AB1DK23L-8864 CONTI 9 10-19 P 898 FIRESTONE W01-358-8864 PETERBILT/PACCAR C81-1011
566-24-3-289 PISTON 566-20-7-431	1R12-1204 	ASA-92-8-041 	566-20-7-431 	AUTOMANN AB1DK23I-8813 CONTI 9 10-14 P 577 FIRESTONE W01-358-8813 KENWORTH C81-1003 PETERBILT C81-6000

- Bolt or Stud – 1/2-13 or 1/2-20
- ⊗ Air Fitting – 1/4 NPTF
- ⊙ Stud – 3/4-10
- ⊕ Tapped Hole on Top Retainers – 3/8-16, on Pistons – 1/2-13
- ⊗ Air Fitting – 1/2 NPTF or 3/8 NPTF
- ⊙ Combination Stud Air Fitting: Stud – 3/4-16, Air Fitting – 1/4 NPTF

BELLOWS NUMBER	SIDE VIEW WITH EXTENDED AND COMPRESSED HEIGHT	UPPER MOUNTING VIEW	LOWER MOUNTING VIEW	MANUFACTURER NUMBERS
566-26-3-015 PISTON 566-20-7-084 ALUMINUM	1R13-070 OBSOLETE 	ASD-20-8-053 	3/4-10 	CONTI 910-19P444 LOAD GUARD SC2776 MACK TRUCK 57QL332 57QL39306 NEWAY 905-44-608 905-57-070 905-57-087 TRIANGLE 8444
566-26-3-043 PISTON 566-20-7-080 COMPOSITE	1R13-117 	ASA-92-8-004 		AUTOMANN AB1DK23Q-9275 CONTI 9 10B-17.5 A 323 64371 FIRESTONE 9275 W013589275 RIDEWELL 1003589275C TRIANGLE 8323 TRP AS92750
566-26-3-044 PISTON 566-20-7-006 ALUMINUM	1R13-115 	ASA-92-8-004 		AUTOMANN AB1DK23S-9250 CONTI 9 10D-21 A 324 64375 FIRESTONE 9250 W013589250 RIDEWELL 1003589250C TRIANGLE 8324 TRP AS92500 WATSON & CHALIN AS-0096
566-26-3-044 PISTON 566-20-7-006 ALUMINUM	1R13-116 	ASA-92-8-044 		AUTOMANN AB1DK23S-9252 CONTI 64376 9 10D-21 A 363 FIRESTONE 9252 W013589252 RIDEWELL 1003589252C TRIANGLE 8363 TRP AS92520
566-26-3-050 PISTON 566-20-7-127 STEEL	1R13-124 	ASA-92-8-230 		AUTOMANN AB1DK25B-8710 AB1DK25B-8755 CONTI 10 10-15 S 522 64397 FIRESTONE 8710 8755 W013588710 W013588755 HENDRICKSON B-22046 C-21623 C-22045 C-22046 SPRINGRIDE 1R13-260 TRIANGLE 8522 TRP AS87550

- Bolt or Stud – 1/2-13 or 1/2-20
- ⊗ Air Fitting – 1/4 NPTF
- ⊙ Stud – 3/4-10
- ⊕ Tapped Hole on Top Retainers – 3/8-16, on Pistons – 1/2-13
- ⊗ Air Fitting – 1/2 NPTF or 3/8 NPTF
- ⊙ Combination Stud Air Fitting: Stud – 3/4-16, Air Fitting – 1/4 NPTF

AIR SPRING ROLLING LOBES

AIR SPRING ROLLING LOBES

AIR SPRING ROLLING LOBES

BELLOWS NUMBER	SIDE VIEW WITH EXTENDED AND COMPRESSED HEIGHT	UPPER MOUNTING VIEW	LOWER MOUNTING VIEW	MANUFACTURER NUMBERS
566-26-3-050 PISTON 566-20-7-106 STEEL	1R13-138 	ASA-92-8-245 		AUTOMANN AB1DK25B-8752 CONTI 10 10-15 S 518 64396 FIRESTONE 8752 W013588752 TRP AS87520
566-26-3-051 PISTON 566-20-7-327 COMPOSITE	1R13-039 	ASA-92-8-245 		AUTOMANN AB1D286-9121 AB1DK23K-9228 AB1DK25E-5783 CONTI 10 10-16.5 S 783 64746 DAYTON 352-9121 FIRESTONE 9121 W013589121 HDA PMABG-9123B HENDRICKSON B-3411 INT'L/NAVISTAR 554773C1 LOAD GUARD SC2040 NEWAY 905-57-019 905-57-052 905-57-078 NEWAY CONT. 905-57-083 AR-1115-1-G R&S TRUCK & BODY 1090023 REYCO 12882-02 RIDEWELL 1003589121C S-3052-C SAUR AXLES P50-733B TAURUS AS621-9121 TRIANGLE 8317 TRP AS91210 WATSON & CHALIN AS-0013 AS-0083
566-26-3-051 PISTON 566-20-7-096 STEEL	1R13-047 	ASA-92-8-245 		CONTI 11 10.5-17 A 377 64347 FIRESTONE W013589144 NEWAY 905-57-110 TRIANGLE 8377 TRP AS91440
566-26-3-051 SERVICE ASSEMBLY FOR 1R13-039 PISTON NOT INCLUDED	1R13-049 	ASA-92-8-245 	USE EXISTING SUPER CUSHION PISTON	INT'L/NAVISTAR 554775C1 LOAD GUARD SC2055 NEWAY 900-44-670 900-44-702 905-54-060 RIDEWELL 1013589123C TAURUS AS621-9123

- Bolt or Stud – 1/2-13 or 1/2-20
- ⊗ Air Fitting – 1/4 NPTF
- ⊙ Stud – 3/4-10
- ⊕ Tapped Hole on Top Retainers – 3/8-16, on Pistons – 1/2-13
- ⊗ Air Fitting – 1/2 NPTF or 3/8 NPTF
- ⊙ Combination Stud Air Fitting: Stud – 3/4-16, Air Fitting – 1/4 NPTF

BELLOWS NUMBER	SIDE VIEW WITH EXTENDED AND COMPRESSED HEIGHT	UPPER MOUNTING VIEW	LOWER MOUNTING VIEW	MANUFACTURER NUMBERS
566-26-3-051 PISTON 566-20-7-036 ALUMINUM	1R13-053 	ASA-20-8-245 		FIRESTONE 8754 W013588754 NEWAY 13
566-26-3-051 PISTON 566-20-7-036-03 ALUMINUM	1R13-075 	ASA-92-8-245 		
566-26-3-051 PISTON 566-20-7-106 STEEL	1R13-155 	ASA-92-8-243 		AUTOMANN AB1DK25E-8637 AB1DK28A-8050 CONTI 10 10-16 S 724 64649 WATSON & CHALIN AS-0107G
566-26-3-051 PISTON 566-20-7-124 STEEL	1R13-181 	ASA-92-8-245 		
566-26-3-051 PISTON 566-20-7-124 STEEL	1R13-182 	ASA-92-8-243 		

- Bolt or Stud – 1/2-13 or 1/2-20
- ⊗ Air Fitting – 1/4 NPTF
- ⊙ Stud – 3/4-10
- ⊕ Tapped Hole on Top Retainers – 3/8-16, on Pistons – 1/2-13
- ⊗ Air Fitting – 1/2 NPTF or 3/8 NPTF
- ⊙ Combination Stud Air Fitting: Stud – 3/4-16, Air Fitting – 1/4 NPTF

AIR SPRING ROLLING LOBES

AIR SPRING ROLLING LOBES

AIR SPRING ROLLING LOBES

BELLOWS NUMBER	SIDE VIEW WITH EXTENDED AND COMPRESSED HEIGHT	UPPER MOUNTING VIEW	LOWER MOUNTING VIEW	MANUFACTURER NUMBERS
566-26-3-054 PISTON 566-20-7-334 ALUMINUM	1R13-120 	ASA-92-8-049 		AUTOMANN AB1DK28L-9218 CONTI 11 10.5-15 A 422 64428 FIRESTONE 9218 W013589218 NEWAY 905-57-209 RIDEWELL 1003589218C TRIANGLE 8422 WATSON & CHALIN AS-0073
566-26-3-055 PISTON 566-20-7-230 COMPOSITE	1R13-130 	ASA-92-8-245 		AUTOMANN AB1DK25D-8729 CONTI 10 10.5AV-12 P 513 64420 FIRESTONE 8729 W013588729 MERITOR 202796 SPRINGRIDE 1R13-261 SUSPENSIONS INC. 202796 TRIANGLE 8513 TRP AS87290
566-26-3-056 PISTON 566-20-7-231 STEEL	1R13-133 	ASA-92-8-307 		DINA 224-B020018 MCI 1510979
566-26-3-067 PISTON 566-20-7-014 STEEL	1R12-435 	ASA-92-8-162 		CONTI 9 10-10 P 471 64439 FIRESTONE 9307 9334 NEWAY 905-57-129 RIDEWELL 1003589334C TRIANGLE 8471 8482 TRP AS93070 AS93340
566-26-3-068 PISTON 566-20-7-325 COMPOSITE	1R13-118 	ASA-92-8-240 		AUTOMANN AB1DK25C-9580 CONTI 10 10-21 P 434 64394 FIRESTONE 9262 9580 W013589580 FLEETRITE 1R13-247 HENDRICKSON 29892 C-20127 C-20414 SPRINGRIDE 1R13-258 TRIANGLE 8434 TRP AS95800

- Bolt or Stud – 1/2-13 or 1/2-20
- ⊗ Tapped Hole on Top Retainers – 3/8-16, on Pistons – 1/2-13
- ⊗ Air Fitting – 1/4 NPTF
- ⊗ Air Fitting – 1/2 NPTF or 3/8 NPTF
- ⊙ Stud – 3/4-10
- ⊗ Combination Stud Air Fitting: Stud – 3/4-16, Air Fitting – 1/4 NPTF

BELLOWS NUMBER	SIDE VIEW WITH EXTENDED AND COMPRESSED HEIGHT	UPPER MOUNTING VIEW	LOWER MOUNTING VIEW	MANUFACTURER NUMBERS
566-26-3-068 PISTON 566-20-7-127 STEEL	1R13-149 	ASA-92-8-240 		
566-26-3-069 PISTON 566-20-7-334 ALUMINUM	1R13-151 	ASA-92-8-326 		
566-26-3-071 PISTON 566-20-7-235 COMPOSITE	1R13-152 	ASA-92-8-245 		AUTOMANN AB1DK25C-8748 CONTI 10 10-21 P 570 64252 FIRESTONE 8748 W013588748 NEWAY 905-57-167 AR-250-14 AR-250-15 TRP AS87480
566-26-3-071 PISTON 566-20-7-237 COMPOSITE	1R13-153 	ASA-92-8-245 		AUTOMANN AB1DK25C-8749 CONTI 1010-21P486 64419 FIRESTONE 8749 W013588749 NEWAY 905-57-168 AR-250-12 AR-250-16 AR-250-17 TRIANGLE 8486 TRP AS87490
566-26-3-071 PISTON 566-20-7-235 COMPOSITE	1R13-208 	ASA-92-8-249 		AUTOMANN AB1DK25C-8746 CONTI 1010-21P774 64728 FIRESTONE W013588746

- Bolt or Stud – 1/2-13 or 1/2-20
- ⊗ Tapped Hole on Top Retainers – 3/8-16, on Pistons – 1/2-13
- ⊗ Air Fitting – 1/4 NPTF
- ⊗ Air Fitting – 1/2 NPTF or 3/8 NPTF
- ⊙ Stud – 3/4-10
- ⊗ Combination Stud Air Fitting: Stud – 3/4-16, Air Fitting – 1/4 NPTF

AIR SPRING ROLLING LOBES

AIR SPRING ROLLING LOBES

AIR SPRING ROLLING LOBES

BELLOWS NUMBER	SIDE VIEW WITH EXTENDED AND COMPRESSED HEIGHT	UPPER MOUNTING VIEW	LOWER MOUNTING VIEW	MANUFACTURER NUMBERS
566-26-3-072 PISTON 566-20-7-097 COMPOSITE	1R13-038 	ASA-92-8-245 		AUTOMANN AB1D28C-A026 CONTI 1110-5-21A313 64273 DAYTON 352-9122 FIRESTONE 9122 FLEETRITE 1R13-246 HENDRICKSON B-12514-008 B-3830 C-22173 S-3467 S-3830 INT'L/NAVISTAR 554772C1 LOAD GUARD SC2041 NEWAY 905-57-020 905-57-071 NEWAY CONTI 905-57-076 905-57-077 905-57-185 AR-1215-1-G REYCO 12883-02 RIDEWELL 1003589122C S-3053-C SPRINGRIDE 1R13-257 TAURUS AS622-9122 TOYO TR1-270/476 TRP AS91220 WATSON & CHALIN AS-0023
566-26-3-072 SERVICE ASSEMBLY FOR 1R13-038 PISTON NOT INCLUDED		ASA-92-8-245 	USE EXISTING SUPER CUSHION PISTON	INT'L/NAVISTAR 554774C1 LOAD GUARD SC2056 NEWAY 900-44-658 900-44-668 RIDEWELL 1013589124C TAURUS AS622-9124
566-26-3-072 PISTON 566-20-7-097 STEEL	1R13-216 	ASA-92-8-245 		
566-26-3-073 PISTON 566-20-7-154 COMPOSITE	1R13-159 	ASA-92-8-230 		AUTOMANN AB1DK25A-8709 AB1DK25B-8751 CONTI 1010-5-15P460 64645 FIRESTONE 8709 8751 W013588709 W013588751 FLEETRITE 1R13-249 HENDRICKSON C-20900 C-21800 SPRINGRIDE 1R13-262 TRIANGLE 8460 TRP AS87090

- Bolt or Stud – 1/2-13 or 1/2-20
- ⊗ Tapped Hole on Top Retainers – 3/8-16, on Pistons – 1/2-13
- ⊗ Air Fitting – 1/4 NPTF
- ⊗ Air Fitting – 1/2 NPTF or 3/8 NPTF
- ⊙ Stud – 3/4-10
- ⊗ Combination Stud Air Fitting: Stud – 3/4-16, Air Fitting – 1/4 NPTF

BELLOWS NUMBER	SIDE VIEW WITH EXTENDED AND COMPRESSED HEIGHT	UPPER MOUNTING VIEW	LOWER MOUNTING VIEW	MANUFACTURER NUMBERS
566-26-3-078 REPLACED BY 1R13-188 PISTON 566-20-7-152 COMPOSITE	1R13-128 			DANA/SPICER SR1VA101
566-26-3-078 PISTON 566-20-7-154 COMPOSITE	1R13-174 OBSOLETE 	ASA-92-8-401 		DANA/SPICER SR1VA101
566-26-3-078 PISTON 566-20-7-154 COMPOSITE	1R13-176 	ASA-92-8-325 		CONTI 1010-165533 64636 FIRESTONE 8713 W013588713 HENDRICKSON C-22948 SPRINGRIDE 1R13-263 TRIANGLE 8533
566-26-3-078 PISTON 566-20-7-154 COMPOSITE	1R13-177 	ASA-92-8-274 		CONTI 1010-165526 64638 FIRESTONE 8708 W013588708 FLEETRITE 1R13-250 HENDRICKSON C-21966 SPRINGRIDE 1R13-264 TRIANGLE 8526
566-26-3-078 PISTON 566-20-7-152 COMPOSITE	1R13-179 	ASA-92-8-245 		

- Bolt or Stud – 1/2-13 or 1/2-20
- ⊗ Tapped Hole on Top Retainers – 3/8-16, on Pistons – 1/2-13
- ⊗ Air Fitting – 1/4 NPTF
- ⊗ Air Fitting – 1/2 NPTF or 3/8 NPTF
- ⊙ Stud – 3/4-10
- ⊗ Combination Stud Air Fitting: Stud – 3/4-16, Air Fitting – 1/4 NPTF

AIR SPRING ROLLING LOBES

AIR SPRING ROLLING LOBES

AIR SPRING ROLLING LOBES

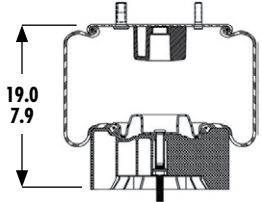
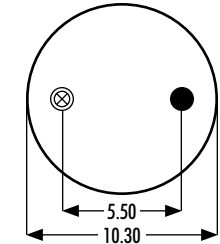
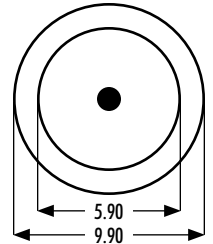
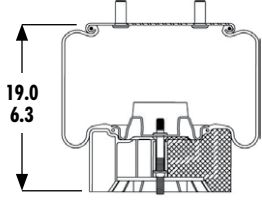
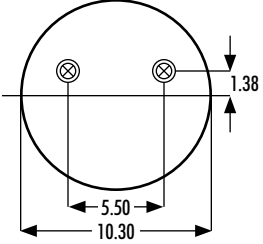
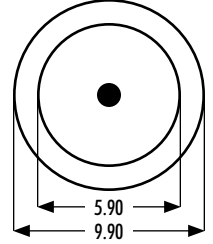
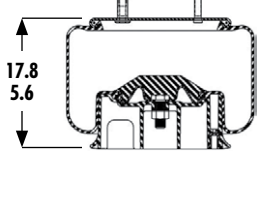
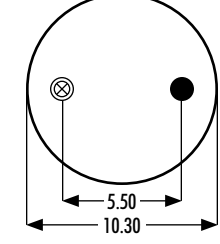
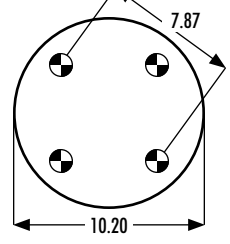
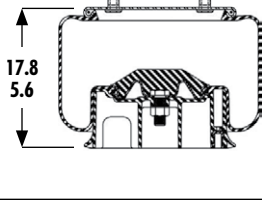
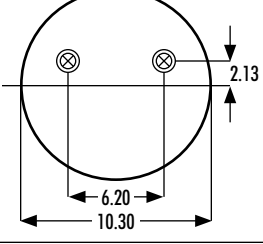
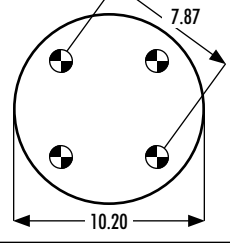
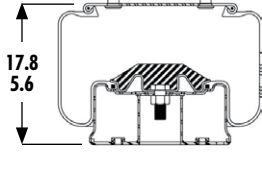
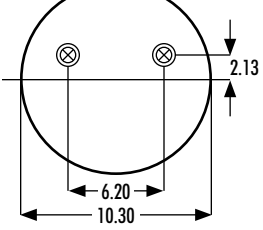
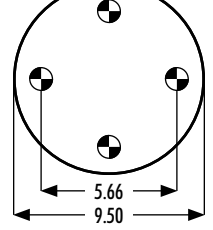
BELLOWS NUMBER	SIDE VIEW WITH EXTENDED AND COMPRESSED HEIGHT	UPPER MOUNTING VIEW	LOWER MOUNTING VIEW	MANUFACTURER NUMBERS
566-26-3-078 PISTON 566-20-7-314 COMPOSITE				DANA/SPICER SR1JA100 SR1VA101-1 SR1VA105 HENDRICKSON S-29892
566-26-3-078 PISTON 566-20-7-152 COMPOSITE				
566-26-3-081 PISTON 566-20-7-296 COMPOSITE				AUTOMANN AB1DK258-8723 CONTI 1010-15S518 1010-15S962 67600 RIDEWELL 1001R13-087 1001R13-097 1003588725C TRIANGLE 8518
566-26-3-081 PISTON 566-20-7-296 COMPOSITE				AUTOMANN AB1DK258-8782 CONTI 10 10-13.5 S 871 66340 FIRESTONE 8782 W013588782 RIDEWELL 1001R13-109 TRP AS87820
566-26-3-081 PISTON 566-20-7-106 STEEL				AUTOMANN AB1DK258-8753 CONTI 10 10-15 S 713 64639 FIRESTONE W013588753 WATSON & CHALIN AS0098

- Bolt or Stud – 1/2-13 or 1/2-20
- ⊗ Air Fitting – 1/4 NPTF
- ⊙ Stud – 3/4-10
- ⊕ Tapped Hole on Top Retainers – 3/8-16, on Pistons – 1/2-13
- ⊗ Air Fitting – 1/2 NPTF or 3/8 NPTF
- ⊙ Combination Stud Air Fitting: Stud – 3/4-16, Air Fitting – 1/4 NPTF

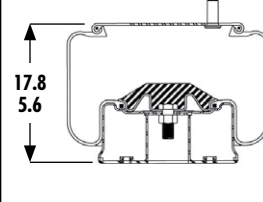
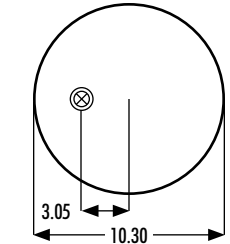
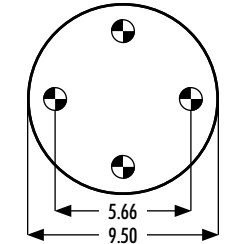
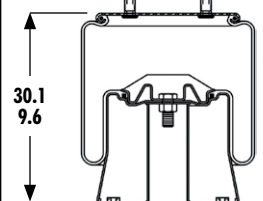
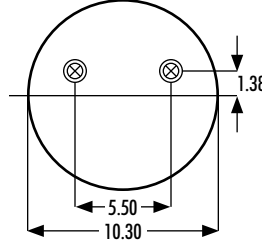
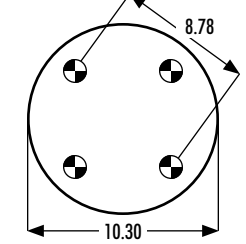
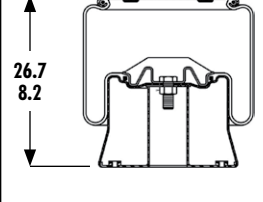
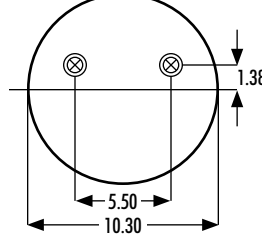
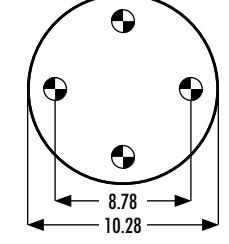
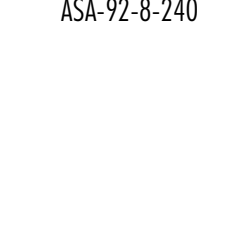
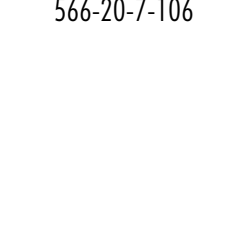
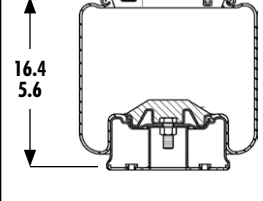
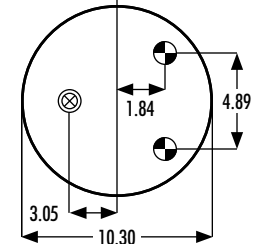
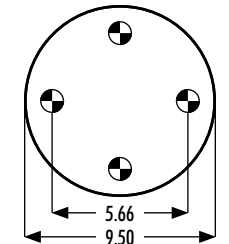
BELLOWS NUMBER	SIDE VIEW WITH EXTENDED AND COMPRESSED HEIGHT	UPPER MOUNTING VIEW	LOWER MOUNTING VIEW	MANUFACTURER NUMBERS
566-26-3-081 PISTON 566-20-7-106 STEEL				AUTOMANN AB1DK258-8740 CONTI 10 10-15 S 773 64725 FIRESTONE W013588740
566-26-3-095 PISTON 566-20-7-274 STEEL				HENDRICKSON S-25872
566-26-3-097 PISTON 566-20-7-277 STEEL				HENDRICKSON S-25871
566-26-3-098 PISTON 566-20-7-106 STEEL				CONTI 9 10-13.5 S 433 64287 FIRESTONE 9270 W013589270 FLEETRITE 1R13-248 HENDRICKSON C-20010 S-20010
566-26-3-098 PISTON 566-20-7-106 STEEL				CONTI 64287 9 10-13.5 S 433 FIRESTONE 9270 W013589270 HENDRICKSON 1R13-102 C-21208 S-25559 TRIANGLE 8433 WATSON & CHALIN AS-0084

- Bolt or Stud – 1/2-13 or 1/2-20
- ⊗ Air Fitting – 1/4 NPTF
- ⊙ Stud – 3/4-10
- ⊕ Tapped Hole on Top Retainers – 3/8-16, on Pistons – 1/2-13
- ⊗ Air Fitting – 1/2 NPTF or 3/8 NPTF
- ⊙ Combination Stud Air Fitting: Stud – 3/4-16, Air Fitting – 1/4 NPTF

AIR SPRING ROLLING LOBES

AIR SPRING ROLLING LOBES

AIR SPRING ROLLING LOBES

BELLOWS NUMBER	SIDE VIEW WITH EXTENDED AND COMPRESSED HEIGHT	UPPER MOUNTING VIEW	LOWER MOUNTING VIEW	MANUFACTURER NUMBERS
566-28-3-015 PISTON 566-20-7-334 ALUMINUM	1R14-037 	ASA-92-8-028 		AUTOMANN AB1DK28L-9215 CONTI 11 10.5-15 A 414 64424 DAYTON 352-9215 FIRESTONE 9215 W013589215 HENDRICKSON B-3648 INT'L/NAVISTAR 554781C1 LOAD GUARD SC2047 TRIANGLE 8414
566-28-3-015 PISTON 566-20-7-334 ALUMINUM	1R14-038 	ASA-92-8-031 		AUTOMANN AB1DK28L-9200 CONTI 11 10.5-15 A 415 64253 DAYTON 352-9200 FIRESTONE 9200 W013589200 HENDRICKSON B-3839 INT'L/NAVISTAR 1681746C1 LOAD GUARD SC2116 RIDEWELL 1003589200C S-2572-C SUSPENSIONS INC. 200458 TRIANGLE 8415 WATSON & CHALIN AS-0082
566-28-3-015 PISTON 566-20-7-334-03 ALUMINUM	1R14-042 	ASA-92-8-049 		AUTOMANN AB1DK28A-8052 CONTI 11 10.5C-16 A 378 64357 FIRESTONE 8052 W013588052 HENDRICKSON 36514-12 B-12514-012 INT'L/NAVISTAR 1681747C1 LOAD GUARD SC2121 TRIANGLE 8378 WATSON & CHALIN AS-0078
566-28-3-015 PISTON 566-20-7-334 ALUMINUM	1R14-052 	ASA-92-8-122 		HENDRICKSON B-9001
566-28-3-015 PISTON 566-20-7-334-03 ALUMINUM	1R14-094 	ASA-92-8-223 		GILLIG 53-20415-0001

- Bolt or Stud – 1/2-13 or 1/2-20
- ⊗ Air Fitting – 1/4 NPTF
- ⊙ Stud – 3/4-10
- ⊕ Tapped Hole on Top Retainers – 3/8-16, on Pistons – 1/2-13
- ⊗ Air Fitting – 1/2 NPTF or 3/8 NPTF
- ⊙ Combination Stud Air Fitting: Stud – 3/4-16, Air Fitting – 1/4 NPTF

BELLOWS NUMBER	SIDE VIEW WITH EXTENDED AND COMPRESSED HEIGHT	UPPER MOUNTING VIEW	LOWER MOUNTING VIEW	MANUFACTURER NUMBERS
566-28-3-015 PISTON 566-20-7-334 ALUMINUM	1R14-108 	ASA-92-8-031 		
566-28-3-015 PISTON 566-20-7-334 ALUMINUM	1R14-155 	ASA-92-8-030 		AUTOMANN AB1DK28A-A729 CONTI 11 10.5C-16 A 729 64660
566-28-3-015 PISTON 566-20-7-223 STEEL	1R14-167 	ASA-92-8-393 		
566-28-3-015 PISTON 566-20-7-334 ALUMINUM	1R14-198 	ASA-92-8-100 		AUTOMANN AB1DK28A-A706 CONTI 11 10.5C-16 A 706 64628
566-28-3-015 PISTON 566-20-7-230 COMPOSITE	1R14-205 	ASA-92-8-434 		MCI 12-01-1143

- Bolt or Stud – 1/2-13 or 1/2-20
- ⊗ Air Fitting – 1/4 NPTF
- ⊙ Stud – 3/4-10
- ⊕ Tapped Hole on Top Retainers – 3/8-16, on Pistons – 1/2-13
- ⊗ Air Fitting – 1/2 NPTF or 3/8 NPTF
- ⊙ Combination Stud Air Fitting: Stud – 3/4-16, Air Fitting – 1/4 NPTF

AIR SPRING ROLLING LOBES

AIR SPRING ROLLING LOBES

AIR SPRING ROLLING LOBES

BELLOWS NUMBER	SIDE VIEW WITH EXTENDED AND COMPRESSED HEIGHT	UPPER MOUNTING VIEW	LOWER MOUNTING VIEW	MANUFACTURER NUMBERS
566-28-3-015 PISTON 566-20-7-334 ALUMINUM	1R14-216 	ASA-92-8-434 		MCI 12-01-1249
566-28-3-020 PISTON 566-20-7-097 COMPOSITE	1R14-019 	ASA-92-8-028 		AUTOMANN AB1D28C-9156 CONTI 11 10.5-21 A 370 64354 FIRESTONE 9152 W013589152 HENDRICKSON B-7128 INT'L/NAVISTAR 554777C1 LOAD GUARD SC2044 PEERLESS 0550-00080 0550-00081 TAURUS AS622-9156 TRIANGLE 8370
566-28-3-020 SERVICE ASSEMBLY FOR 1R14-019 PISTON NOT INCLUDED	1R14-025 	ASA-92-8-078 	USE EXISTING SUPER CUSHION PISTON	INT'L/NAVISTAR 1681742C1 LOAD GUARD SC2111
566-28-3-020 PISTON 566-20-7-097 COMPOSITE	1R14-030 	ASA-92-8-031 		AUTOMANN AB1D28C-9158 CONTI 11 10.5-21 A 318 64352 DAYTON 352-9158 FIRESTONE 9158 W013589158 HENDRICKSON 36514-1 36514-4 B-12514-004 B-2063 INT'L/NAVISTAR 554780C1 LOAD GUARD SC2045 NEWAY 905-57-005 905-57-069 AR-1215-1-F RIDEWELL 1003589158C S-2574-C TAURUS AS622-9158 TRIANGLE 8318 TRP AS91580
566-28-3-020 SERVICE ASSEMBLY FOR 1R14-030 PISTON NOT INCLUDED	1R14-031 	ASC-92-8-079 	USE EXISTING SUPER CUSHION PISTON	INT'L/NAVISTAR 1681745C1 LOAD GUARD SC2115 NEWAY 900-44-197 RIDEWELL 1013589154C TAURUS AS622-9154

- Bolt or Stud – 1/2-13 or 1/2-20
- ⊗ Air Fitting – 1/4 NPTF
- ⊙ Stud – 3/4-10
- ⊕ Tapped Hole on Top Retainers – 3/8-16, on Pistons – 1/2-13
- ⊗ Air Fitting – 1/2 NPTF or 3/8 NPTF
- ⊙ Combination Stud Air Fitting: Stud – 3/4-16, Air Fitting – 1/4 NPTF

BELLOWS NUMBER	SIDE VIEW WITH EXTENDED AND COMPRESSED HEIGHT	UPPER MOUNTING VIEW	LOWER MOUNTING VIEW	MANUFACTURER NUMBERS
566-28-3-020 PISTON 566-20-7-097 COMPOSITE	1R14-045 	ASA-92-8-049 		AUTOMANN AB1D28C-9122 CONTI 11 10.5-21 A 313 64273 FIRESTONE 8792 9122 W013588792 W013589122 HENDRICKSON 36514-2 36514-8 B-3467 INT'L/NAVISTAR 1681748C1 LOAD GUARD SC2098 TRIANGLE 8313 TRP AS91220
566-28-3-020 SERVICE ASSEMBLY FOR 1R14-045 PISTON NOT INCLUDED	1R14-060 	ASA-92-8-116 	USE EXISTING SUPER CUSHION PISTON	INT'L/NAVISTAR 1681749C1 LOAD GUARD SC2099
566-28-3-020 PISTON 566-20-7-096 COMPOSITE	1R14-151 	ASA-92-8-100 		CONTI 1110-5-19A960 67547 RIDEWELL 1000006
566-28-3-020 PISTON 566-20-7-097 COMPOSITE	1R14-154 	ASA-92-8-361 		WATSON & CHALIN AS-0023-16
566-28-3-020 PISTON 566-20-7-097 COMPOSITE	1R14-170 	ASA-92-8-174 		AUTOMANN AB1DK28F-A752 CONTI 11 10.5-22 A 752 34690 NEWAY 905-57-102 TRP AS55031 WATSON & CHALIN AS-00476

- Bolt or Stud – 1/2-13 or 1/2-20
- ⊗ Air Fitting – 1/4 NPTF
- ⊙ Stud – 3/4-10
- ⊕ Tapped Hole on Top Retainers – 3/8-16, on Pistons – 1/2-13
- ⊗ Air Fitting – 1/2 NPTF or 3/8 NPTF
- ⊙ Combination Stud Air Fitting: Stud – 3/4-16, Air Fitting – 1/4 NPTF

AIR SPRING ROLLING LOBES

AIR SPRING ROLLING LOBES

AIR SPRING ROLLING LOBES

BELLOWS NUMBER	SIDE VIEW WITH EXTENDED AND COMPRESSED HEIGHT	UPPER MOUNTING VIEW	LOWER MOUNTING VIEW	MANUFACTURER NUMBERS
566-28-3-020 PISTON 566-20-7-097 COMPOSITE	1R14-174 	ASA-92-8-049 		AUTOMANN AB1DK28F-5503 CONTI 11 10.5-22 A 530 64422 FIRESTONE 5503 W013585503 NEWAY 905-57-200 TRIANGLE 8530 TRP AS55030 WATSON & CHALIN AS-0047
566-28-3-020 PISTON 566-20-7-181 STEEL	1R14-176 	ASA-92-8-100 		
566-28-3-020 PISTON 566-20-7-097 STEEL	1R14-201 	ASA-92-8-100 		AUTOMANN AB1D28C-A965 CONTI 11 10.5-21 A 965 67625
566-28-3-020 PISTON 566-20-7-096 STEEL	1R14-209 	ASA-92-8-237 		
566-28-3-021 PISTON 566-20-7-096 STEEL	1R14-018 	ASA-92-8-028 		AUTOMANN AB1D28G-9149 CONTI 11 10.5-17 A 365 64344 DAYTON 352-9149 FIRESTONE 9149 W013589149 GILLIG 53-13188 INT'L/NAVISTAR 554776C1 LOAD GUARD SC2043 PEERLESS 0550-00010 TAURUS AS621-9149 TRIANGLE 8365

- Bolt or Stud – 1/2-13 or 1/2-20
- ⊗ Air Fitting – 1/4 NPTF
- ⊙ Stud – 3/4-10
- ⊕ Tapped Hole on Top Retainers – 3/8-16, on Pistons – 1/2-13
- ⊗ Air Fitting – 1/2 NPTF or 3/8 NPTF
- ⊙ Combination Stud Air Fitting: Stud – 3/4-16, Air Fitting – 1/4 NPTF

BELLOWS NUMBER	SIDE VIEW WITH EXTENDED AND COMPRESSED HEIGHT	UPPER MOUNTING VIEW	LOWER MOUNTING VIEW	MANUFACTURER NUMBERS
566-28-3-021 PISTON 566-20-7-096 STEEL	1R14-026 	ASA-92-8-028 		AUTOMANN AB1D28G-9148 CONTI 11 10.5-17 A 364 64343 DAYTON 352-9148 FIRESTONE 9148 W013589148 INT'L/NAVISTAR 554778C1 LOAD GUARD SC2042 PEERLESS 0550-00070 TAURUS AS621-9148 TRIANGLE 8364
566-28-3-021 PISTON 566-20-7-096 STEEL	1R14-028 	ASA-92-8-031 		AUTOMANN AB1D28G-9177 CONTI 11 10.5-17 A 316 64342 DAYTON 352-9177 FIRESTONE 9177 W013589177 HDA PMABG-9177B HENDRICKSON B-2065 INT'L/NAVISTAR 554779C1 LOAD GUARD SC2046 NEWAY 905-57-003 AR-1115-1-F R&S TRUCK & BODY 1090216 RIDEWELL 103589177C S-2573-C S-4695-C S-4797-C TAURUS AS621-9177 AS621-9179 TRIANGLE 8316 8366 WATSON & CHALIN AS-0010
566-28-3-021 PISTON 566-20-7-080 COMPOSITE	1R14-101 	ASA-92-8-048 		FLXIBLE 87-0808-00001 97-5382-001 97-6694-1
566-28-3-021 PISTON 566-20-7-188 STEEL	1R14-106 	ASA-92-8-279 		MCI 12-03-1029 TAURUS AS621-9961

- Bolt or Stud – 1/2-13 or 1/2-20
- ⊗ Air Fitting – 1/4 NPTF
- ⊙ Stud – 3/4-10
- ⊕ Tapped Hole on Top Retainers – 3/8-16, on Pistons – 1/2-13
- ⊗ Air Fitting – 1/2 NPTF or 3/8 NPTF
- ⊙ Combination Stud Air Fitting: Stud – 3/4-16, Air Fitting – 1/4 NPTF

AIR SPRING ROLLING LOBES

AIR SPRING ROLLING LOBES

AIR SPRING ROLLING LOBES

BELLOWS NUMBER	SIDE VIEW WITH EXTENDED AND COMPRESSED HEIGHT	UPPER MOUNTING VIEW	LOWER MOUNTING VIEW	MANUFACTURER NUMBERS
566-28-3-021 PISTON 566-20-7-097 STEEL	1R14-115 	ASA-92-8-028 		AUTOMANN AB1D286-9961 CONTI 11 10.5-17 A 367 64346 FIRESTONE 9961 W013589961 RIDEWELL 1003589961C TAURUS AS621-9961 TRIANGLE 8367 TRP AS99610
566-28-3-021 PISTON 566-20-7-217 COMPOSITE	1R14-124 	ASA-92-8-048 		FLXIBLE T14-1035
566-28-3-021 PISTON 566-20-7-096 COMPOSITE	1R14-130 	ASA-92-8-318 		AUTOMANN AB1D286-8778 CONTI 11 10.5-17 A 507 64350 FIRESTONE 8778 W013588778
566-28-3-021 PISTON 566-20-7-096 STEEL	1R14-137 	ASA-92-8-049 		AUTOMANN AB1DK288-9134 CONTI 11 10.5-19 A 431 64391 FIRESTONE 9134 W013589134 NEWAY 905-57-125 TRIANGLE 8431 TRP AS91340
566-28-3-021 PISTON 566-20-7-189 STEEL	1R14-141 	ASA-92-8-272 		MCI 12-01-1002 12-01-1048

- Bolt or Stud – 1/2-13 or 1/2-20
- ⊗ Air Fitting – 1/4 NPTF
- ⊙ Stud – 3/4-10
- ⊕ Tapped Hole on Top Retainers – 3/8-16, on Pistons – 1/2-13
- ⊗ Air Fitting – 1/2 NPTF or 3/8 NPTF
- ⊙ Combination Stud Air Fitting: Stud – 3/4-16, Air Fitting – 1/4 NPTF

BELLOWS NUMBER	SIDE VIEW WITH EXTENDED AND COMPRESSED HEIGHT	UPPER MOUNTING VIEW	LOWER MOUNTING VIEW	MANUFACTURER NUMBERS
566-28-3-021 PISTON 566-20-7-096 STEEL	1R14-159 	ASA-92-8-049 		AUTOMANN AB1D286-9164 CONTI 11 10.5-17 A 405 64349 FIRESTONE 9164 W013589164 NEWAY 905-57-111 R&S TRUCK & BODY T090326 TRIANGLE 8405 TRP AS91380
566-28-3-021 PISTON 566-20-7-097 COMPOSITE	1R14-160 	ASA-92-8-049 		AUTOMANN AB1D286-9144 CONTI 11 10.5-17 A 377 64347 FIRESTONE 9144 W013589144 NEWAY 905-57-155 TRIANGLE 8523
566-28-3-021 PISTON 566-20-7-276 STEEL	1R14-177 	ASA-92-8-049 		NABI-HF 5014470
566-28-3-021 PISTON 566-20-7-327 COMPOSITE	1R14-215 	ASA-92-8-049 		FIRESTONE W013589141
566-28-3-021 PISTON 566-20-7-276 STEEL	1R14-218 	ASA-92-8-049 		NABI-HF 5009273

- Bolt or Stud – 1/2-13 or 1/2-20
- ⊗ Air Fitting – 1/4 NPTF
- ⊙ Stud – 3/4-10
- ⊕ Tapped Hole on Top Retainers – 3/8-16, on Pistons – 1/2-13
- ⊗ Air Fitting – 1/2 NPTF or 3/8 NPTF
- ⊙ Combination Stud Air Fitting: Stud – 3/4-16, Air Fitting – 1/4 NPTF

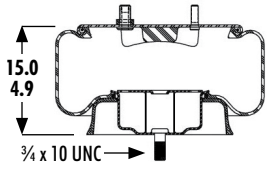
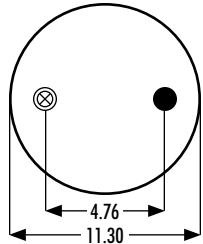
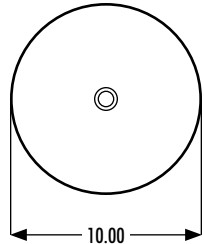
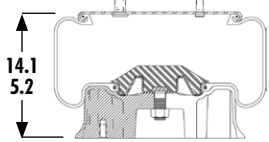
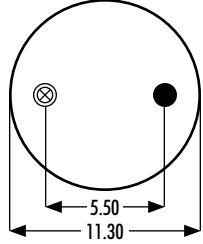
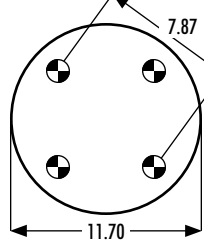
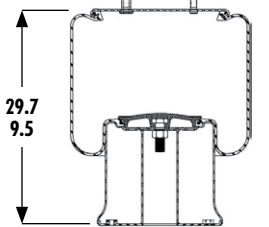
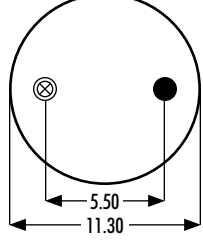
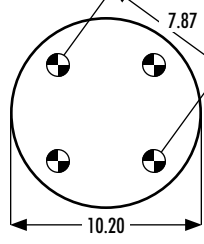
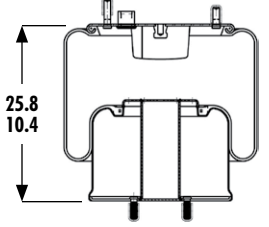
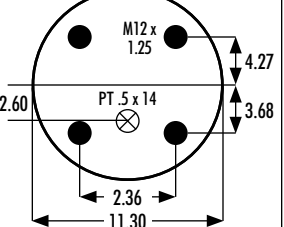
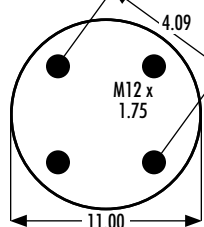
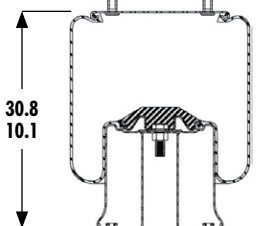
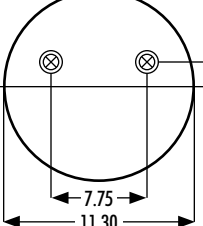
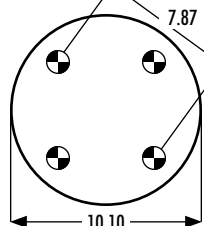

AIR SPRING ROLLING LOBES

AIR SPRING ROLLING LOBES

BELLOWS NUMBER	SIDE VIEW WITH EXTENDED AND COMPRESSED HEIGHT	UPPER MOUNTING VIEW	LOWER MOUNTING VIEW	MANUFACTURER NUMBERS
566-28-3-024 PISTON 566-20-7-050 ALUMINUM	1R14-112 OBSOLETE 	ASA-92-8-221 		FLXIBLE 6-336-183 GMC 2052623 2054879 2090412 61017370 61050310
566-28-3-024 PISTON 566-20-7-334 ALUMINUM	1R14-179 	ASA-92-8-049 		
566-28-3-030 PISTON 566-20-7-181 STEEL	1R14-113 	ASC-92-8-049 		AUTOMANN AB1DK28F-5505 CONTI 11 10.5-22 S 750 64688 FIRESTONE 5505 W013585505 NEWAY 905-57-103
566-28-3-031 PISTON 566-20-7-185 STEEL	1R14-117 	578-92-8-267 		
566-28-3-031 PISTON 566-20-7-181 STEEL	1R14-127 	ASA-92-8-100 		AUTOMANN AB1DK28F-9264 CONTI 11 10.5-22 S 712 64637 FIRESTONE 9264 W013589264 HENDRICKSON C-13122 RIDEWELL 1000002 TRIANGLE 8539

- Bolt or Stud – 1/2-13 or 1/2-20
- ⊗ Air Fitting – 1/4 NPTF
- ⊙ Stud – 3/4-10
- ⊕ Tapped Hole on Top Retainers – 3/8-16, on Pistons – 1/2-13
- ⊗ Air Fitting – 1/2 NPTF or 3/8 NPTF
- ⊙ Combination Stud Air Fitting: Stud – 3/4-16, Air Fitting – 1/4 NPTF

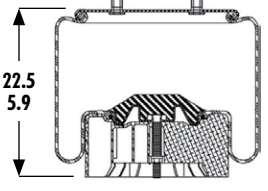
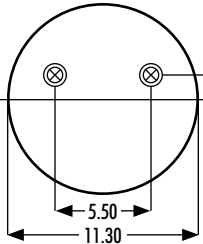
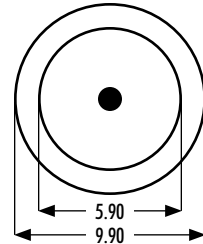
AIR SPRING ROLLING LOBES

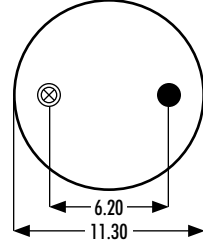
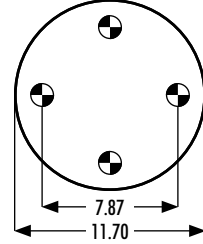
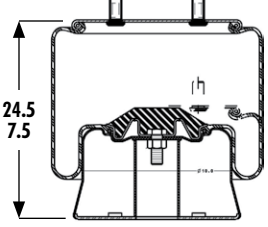
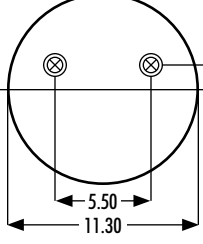
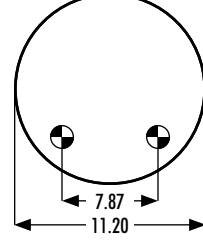
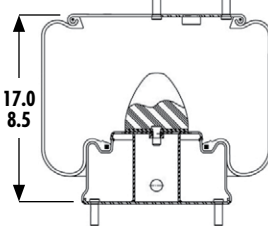
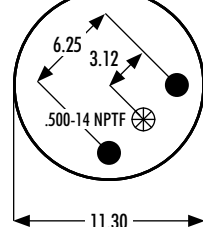
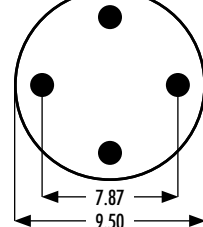
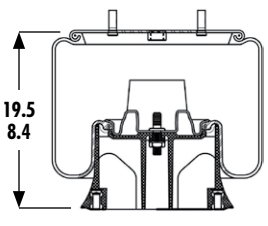
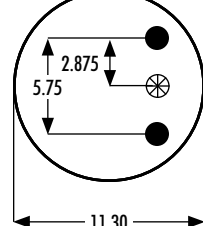
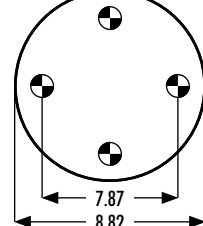
BELLOWS NUMBER	SIDE VIEW WITH EXTENDED AND COMPRESSED HEIGHT	UPPER MOUNTING VIEW	LOWER MOUNTING VIEW	MANUFACTURER NUMBERS
566-28-3-042 PISTON 566-20-7-152 COMPOSITE	1R14-172 	ASA-92-8-237 		AUTOMANN AB1DK28M-8774 CONTI 11 10.5F-17 P 745 65593 FIRESTONE W013588774 HENDRICKSON C-25873 TRP AS87740
566-28-3-042 PISTON 566-20-7-334 ALUMINUM	1R14-175 	ASA-92-8-174 		RIDEWELL 1000008
566-28-3-042 PISTON 566-20-7-323 STEEL	1R14-232 	ASA-92-8-237 		WATSON & CHALIN AS-0241
566-28-3-043 PISTON 566-20-7-304 STEEL	1R14-182 	ASA-92-8-272 		MCI 12-01-1090
566-28-3-043 PISTON 566-20-7-158 COMPOSITE	1R14-222 	ASA-92-8-279 		MCI 12-04-1158

- Bolt or Stud – 1/2-13 or 1/2-20
- ⊗ Air Fitting – 1/4 NPTF
- ⊙ Stud – 3/4-10
- ⊕ Tapped Hole on Top Retainers – 3/8-16, on Pistons – 1/2-13
- ⊗ Air Fitting – 1/2 NPTF or 3/8 NPTF
- ⊙ Combination Stud Air Fitting: Stud – 3/4-16, Air Fitting – 1/4 NPTF

AIR SPRING ROLLING LOBES

AIR SPRING ROLLING LOBES

BELLOWS NUMBER	SIDE VIEW WITH EXTENDED AND COMPRESSED HEIGHT	UPPER MOUNTING VIEW	LOWER MOUNTING VIEW	MANUFACTURER NUMBERS
566-28-3-044 PISTON 566-20-7-152 COMPOSITE	1R14-183 	ASA-92-8-100 		
566-28-3-044 PISTON 566-20-7-152 COMPOSITE	1R14-190 	ASA-92-8-237 		AUTOMANN AB1DK28N-8093 CONTI 11 10.5F-17 P 745 65593 WATSON & CHALIN AS-0144
566-28-3-057 PISTON 566-20-7-274 STEEL	1R14-236 	ASA-92-8-237 		HENDRICKSON S-24446 WATSON & CHALIN AS-0246
566-28-3-059 PISTON 566-20-7-277 STEEL	1R14-240 	ASA-92-8-237 		HENDRICKSON S-24445

- Bolt or Stud – 1/2-13 or 1/2-20
- ⊗ Air Fitting – 1/4 NPTF
- ⊙ Stud – 3/4-10
- ⊕ Tapped Hole on Top Retainers – 3/8-16, on Pistons – 1/2-13
- ⊗ Air Fitting – 1/2 NPTF or 3/8 NPTF
- ⊙ Combination Stud Air Fitting: Stud – 3/4-16, Air Fitting – 1/4 NPTF

AIR SPRING ROLLING LOBES

BELLOWS NUMBER	SIDE VIEW WITH EXTENDED AND COMPRESSED HEIGHT	UPPER MOUNTING VIEW	LOWER MOUNTING VIEW	MANUFACTURER NUMBERS
566-28-3-065 PISTON 566-20-7-334 ALUMINUM	1R14-039 	ASA-92-8-100 		AUTOMANN AB1DK28A-8050 CONTI 11 10.5C-16 A 320 64254 DAYTON 352-8050 FIRESTONE 8050 W013588050 FLEETRITE 1R14-241 HENDRICKSON 36514-13 B-4771 INT'L/NAVISTAR 1685174C1
566-28-3-065 PISTON 566-20-7-152 COMPOSITE	1R14-171 	ASA-92-8-237 		AUTOMANN AB1DK28E-8091 CONTI 11 10.5A-16 P 523 64421 FIRESTONE 8091 W013588091 FLEETRITE 1R14-242
566-28-3-164 PISTON 566-20-7-097 STEEL	1R14-164 	ASA-92-8-402 		
566-30-3-001 PISTON 566-20-7-152 COMPOSITE	1R15-001 	ASA-92-8-237 		

- Bolt or Stud – 1/2-13 or 1/2-20
- ⊗ Air Fitting – 1/4 NPTF
- ⊙ Stud – 3/4-10
- ⊕ Tapped Hole on Top Retainers – 3/8-16, on Pistons – 1/2-13
- ⊗ Air Fitting – 1/2 NPTF or 3/8 NPTF
- ⊙ Combination Stud Air Fitting: Stud – 3/4-16, Air Fitting – 1/4 NPTF

AIR SPRING ROLLING LOBES

AIR SPRING SLEEVES

PART NUMBER	SIDE VIEW WITH EXTENDED AND COMPRESSED HEIGHT	UPPER MOUNTING VIEW	LOWER MOUNTING VIEW	MANUFACTURER NUMBERS
1S3-011 PISTON ASB-06-7-014	 8.0 3.6	 ASB-06-5-012 2.20 .750-16 UNF-2A outside .125-27 NPTF inside	 1.54 .500-13 UNC	FIRESTONE 4001 W023584001 LES AUTOBUS G5006637 LINK CAB & SEAT SPRINGS 1101-0001 NOVABUS N12687 PREVOST 95-0208
1S3-013 PISTON ASC-06-7-017	 3.6 1.5	 ASC-06-5-014 3.20 5/16-18 UNC	 2.40 .625-11 UNC outside .125 NPTF inside	FIRESTONE 3000 3001 W023583000 W023583001 PREVOST 950208
1S4-007 PISTON ASC-08-7-139	 7.1 2.2	 ASB-08-5-007 2.65 .375-16 UNC	 2.87 .750-16 UNF-2A outside .125-27 NPTF inside	CONTI 67770 SC29-0001 FIRESTONE 7001 7002 7031 W023587001 W023587002 W023587031 FLXIBLE 97-9999-01867 LINK CAB & SEAT SPRINGS 1101-0020 1102-0023 MACK TRUCK 227Q533
1S4-008 PISTON ASC-08-7-005	 10.5 4.0	 ASB-08-5-006 2.65 .750-16 UNF outside .125-27 NPTF inside	 2.12 .500-13 UNC	FIRESTONE 7010 W023587010 LINK CAB & SEAT SPRINGS 1101-0021 MACK TRUCK 227Q539301
1S4-016 PISTON ASC-08-7-137	 7.1 2.2	 ASB-08-5-132 2.65 .500 O.D. smooth	 3.25 .750 smooth outside .125-27 NPTF inside	INT'L / NAVISTAR 1680378C1

● Bolt or Stud – 1/2-13 or 1/2-20

⊗ Air Fitting – 1/4 NPTF

⊙ Stud – 3/4-10

⊕ Tapped Hole on Top Retainers – 3/8-16, on Pistons – 1/2-13

⊗ Air Fitting – 1/2 NPTF or 3/8 NPTF

⊙ Combination Stud Air Fitting: Stud – 3/4-16, Air Fitting – 1/4 NPTF

AIR SPRING SLEEVES

PART NUMBER	SIDE VIEW WITH EXTENDED AND COMPRESSED HEIGHT	UPPER MOUNTING VIEW	LOWER MOUNTING VIEW	MANUFACTURER NUMBERS
1S4-030 PISTON ASC-08-7-093	 10.5 6.4	 ASB-08-5-006 2.65 .750-16 UNF outside .125-27 NPTF inside	 2.12 .500-13 UNC	FREIGHTLINER 20-12461
1S4-035 PISTON ASC-08-7-163	 10.5 4.0	 ASB-08-5-132 2.65 .500 O.D. smooth	 2.12 .750 smooth outside .125-27 UNC inside	CONTI 62844 S270-5060P02 FIRESTONE 7003 7050 7055 W023587003 W023587050 W023587055
1S4-042 PISTON ASC-08-7-219	 10.5 4.0 Composition Fitting for 0.125 OD Tubing	 AS2-08-5-007 2.65 .375-16 UNC	 2.12 .750 smooth	VOLVO 66003-0007
1S4-044 PISTON ASC-08-7-194	 10.5 4.0	 ASB-08-5-076 2.65 .750 smooth outside .125-27 NPTF inside	 2.12 .500-13 UNC	CONTI 62561 S270-5067 LINK CAB & SEAT SPRINGS 1101-0023
1S4-056 PISTON ASC-08-7-194	 10.5 4.0	 ASB-08-5-129 2.65 .750-16 UNC outside .125-27 NPTF inside	 2.12 .500-13 UNC	FIRESTONE 7040 W023587040 LINK CAB & SEAT SPRINGS 1101-0024

● Bolt or Stud – 1/2-13 or 1/2-20

⊗ Air Fitting – 1/4 NPTF

⊙ Stud – 3/4-10

⊕ Tapped Hole on Top Retainers – 3/8-16, on Pistons – 1/2-13

⊗ Air Fitting – 1/2 NPTF or 3/8 NPTF

⊙ Combination Stud Air Fitting: Stud – 3/4-16, Air Fitting – 1/4 NPTF

AIR SPRING SLEEVES

PART NUMBER	SIDE VIEW WITH EXTENDED AND COMPRESSED HEIGHT	UPPER MOUNTING VIEW	LOWER MOUNTING VIEW	MANUFACTURER NUMBERS
1S4-058 PISTON ASC-08-7-139	 4.5 2.6	AS2-08-5-007 .375-16 UNC 2.65	 .750 smooth outside .125-27 UNC inside 2.88	CONTI 67858 SC29-0086 FIRESTONE 7086 W023587086
1S4-067 PISTON ASC-08-7-137	 7.1 2.2	ASB-08-5-024 .750-16 UNF outside .125-27 NPTF inside 2.65	 .750 smooth outside .125-27 NPTF inside 3.25	FIRESTONE 7007 W023587007 MACK TRUCK 227Q534B
1S4-074 PISTON ASC-08-7-134	 10.0 5.5	AS2-08-5-007 .375-16 UNC 2.65	 .750 smooth outside .125-27 NPTF inside 2.12	VOLVO 66003-3201
1S4-123 PISTON ASC-08-7-157	 7.1 2.2	ASB-08-5-170 .125-27 NPTF .375-16 UNC 0.75 2.65	 .375-16 UNC 3.25	CONTI 67769 SC29-0046 S270-5060P02 FIRESTONE W023587046 LINK CAB & SEAT SPRINGS 1102-0022
1S4-173 PISTON ASC-08-7-137	 7.1 2.2	ASB-08-5-172 3/4-16 UNF 2A 3.15	 .750 smooth outside .125-27 NPTF inside 3.25	

- Bolt or Stud – 1/2-13 or 1/2-20
- ⊗ Air Fitting – 1/4 NPTF
- ⊙ Stud – 3/4-10
- ⊕ Tapped Hole on Top Retainers – 3/8-16, on Pistons – 1/2-13
- ⊗ Air Fitting – 1/2 NPTF or 3/8 NPTF
- ⊙ Combination Stud Air Fitting: Stud – 3/4-16, Air Fitting – 1/4 NPTF

AIR SPRING SLEEVES

PART NUMBER	SIDE VIEW WITH EXTENDED AND COMPRESSED HEIGHT	UPPER MOUNTING VIEW	LOWER MOUNTING VIEW	MANUFACTURER NUMBERS
1S4-175 PISTON ASC-08-7-157	 7.1 2.2	ASB-08-5-076 .750 smooth outside .125-27 NPTF inside 2.65	 .375-16 UNC 3.25	CONTI 67858 SC29-0086 LINK CAB & SEAT SPRINGS 1101-0025
1S4-187 FLEXMEMBER 579-08-1-049	 4.9 2.5	ASB-08-5-129 .750-16 UNC outside .125-27 NPTF inside 2.65	 .750-16 UNF-2A outside .125-27 NPTF inside 2.65	DANA / SPICER SR1VA103
1S4-234 BELLOWS 580-23-4-605 FLEXMEMBER 579-08-1-004 PISTON 579-08-7-317	 7.5 2.2		579-08-7-317	FIRESTONE W02-358-7132 PETERBILT R81-6003
1S4-235 BELLOWS 580-23-4-604 FLEXMEMBER 579-08-1-004 PISTON 579-08-7-317	 8.0 2.2		579-08-7-317	FIRESTONE W02-358-7155 PACCAR 20-19036 PETERBILT R81-6002
1S4.5-073 PISTON ASC-08-7-194	 11.0 4.0	ASB-08-5-076 .750 smooth outside .125-27 NPTF inside 2.65	 .500-13 UNC 2.12	LINK CAB & SEAT SPRINGS 1101-0030

- Bolt or Stud – 1/2-13 or 1/2-20
- ⊗ Air Fitting – 1/4 NPTF
- ⊙ Stud – 3/4-10
- ⊕ Tapped Hole on Top Retainers – 3/8-16, on Pistons – 1/2-13
- ⊗ Air Fitting – 1/2 NPTF or 3/8 NPTF
- ⊙ Combination Stud Air Fitting: Stud – 3/4-16, Air Fitting – 1/4 NPTF

AIR SPRING SLEEVES

AIR SPRING SLEEVES

PART NUMBER	SIDE VIEW WITH EXTENDED AND COMPRESSED HEIGHT	UPPER MOUNTING VIEW	LOWER MOUNTING VIEW	MANUFACTURER NUMBERS
1S4.5-107 PISTON ASC-08-7-194	1S4.5-107 	ASB-08-5-129 		FIRESTONE 7080 W023587080
1S4.5-113 PISTON 579-08-7-219	1S4.5-113 	ASB-08-5-132 		FIRESTONE 7056 W023587056 LINK CAB & SEAT SPRINGS 1102-0043
1S4.5-121 PISTON ASC-08-7-157	1S4.5-121 	ASB-08-5-201 		CONTI 67851 SC29-W035 S270-7065P02 FIRESTONE 7035 W023587035 SEARS SEAT S-20235 S-9383 TRP AS70350
1S4.5-179 PISTON ASC-08-7-157	1S4.5-179 	ASB-08-5-076 		LINK CAB & SEAT SPRINGS 1101-0031
1S5-005 PISTON ASC-08-7-005	1S5-005 	ASB-08-5-006 		LINK CAB & SEAT SPRINGS 1101-0040

- Bolt or Stud – 1/2-13 or 1/2-20
- ⊗ Air Fitting – 1/4 NPTF
- ⊙ Stud – 3/4-10
- ⊕ Tapped Hole on Top Retainers – 3/8-16, on Pistons – 1/2-13
- ⊗ Air Fitting – 1/2 NPTF or 3/8 NPTF
- ⊙ Combination Stud Air Fitting: Stud – 3/4-16, Air Fitting – 1/4 NPTF

AIR SPRING SLEEVES

PART NUMBER	SIDE VIEW WITH EXTENDED AND COMPRESSED HEIGHT	UPPER MOUNTING VIEW	LOWER MOUNTING VIEW	MANUFACTURER NUMBERS
1S5-006 PISTON ASC-08-7-005	1S5-006 	ASB-08-5-006 		FIRESTONE 7017 W023587014 W023587017 W023587042 W023587044 LINK CAB & SEAT SPRINGS 1101-0041
1S5-010 PISTON ASC-08-7-139	1S5-010 	AS2-08-5-007 		CONTI 67882 SC29-YG01
1S5-032 PISTON ASC-08-7-163	1S5-032 	ASB-08-5-132 		LINK CAB & SEAT SPRINGS 1101-0042 1101-A042
1S5-038 PISTON ASC-08-7-194	1S5-038 	ASB-08-5-076 		FIRESTONE 7081 W023587081 LINK CAB & SEAT SPRINGS 1101-0043
1S5-040 PISTON ASC-08-7-137	1S5-040 	ASB-08-5-132 		CONTI 67636 SC29-W087 FIRESTONE 7087 W023587087 FLEETRITE 1S5-040 FREIGHTLINER GYR1S5040 TRP AS70870

- Bolt or Stud – 1/2-13 or 1/2-20
- ⊗ Air Fitting – 1/4 NPTF
- ⊙ Stud – 3/4-10
- ⊕ Tapped Hole on Top Retainers – 3/8-16, on Pistons – 1/2-13
- ⊗ Air Fitting – 1/2 NPTF or 3/8 NPTF
- ⊙ Combination Stud Air Fitting: Stud – 3/4-16, Air Fitting – 1/4 NPTF

AIR SPRING SLEEVES

AIR SPRING SLEEVES

PART NUMBER	SIDE VIEW WITH EXTENDED AND COMPRESSED HEIGHT	UPPER MOUNTING VIEW	LOWER MOUNTING VIEW	MANUFACTURER NUMBERS
1S5-045 PISTON ASC-08-7-139	 6.25 2.25	ASB-08-5-132 .500 O.D. smooth 2.65	 .750-16 UNF-2A outside .125-27 NPTF inside 2.875	FREIGHTLINER GYR1S5045
1S5-055 PISTON ASC-08-7-194	 10.0 4.0	AS2-08-5-063 .750 smooth outside .125-27 NPTF inside 2.65	 .500-13 UNC 2.12	MACK TRUCK 227QS38B
1S5-057 PISTON 579-08-7-157	 6.25 2.2	ASB-08-5-170 .125-27 NPTF .375-16 UNC 0.75 2.65	 .375-16 UNC 3.25	CONTI 67852 SC29-Y108 SZ70-8077P02 FIRESTONE 7108 W023587108 MILSCO 07067A TRP AS71080
1S5-060 PISTON ASC-08-7-219	 9.5 4.0 Compression fitting for 0.125 OD tubing	AS2-08-5-007 .375-16 UNC 2.65	 .750 smooth 2.12	VOLVO 66003-0004
1S5-061 PISTON ASC-08-7-194	 10.5 4.0	AS2-08-5-079 .125-27 NPTF .500-13 UNC 0.75 2.65	 .500-13 UNC 2.12	

● Bolt or Stud – 1/2-13 or 1/2-20

⊗ Air Fitting – 1/4 NPTF

⊙ Stud – 3/4-10

⊕ Tapped Hole on Top Retainers – 3/8-16, on Pistons – 1/2-13

⊗ Air Fitting – 1/2 NPTF or 3/8 NPTF

⊗ Combination Stud Air Fitting: Stud – 3/4-16, Air Fitting – 1/4 NPTF

AIR SPRING SLEEVES

PART NUMBER	SIDE VIEW WITH EXTENDED AND COMPRESSED HEIGHT	UPPER MOUNTING VIEW	LOWER MOUNTING VIEW	MANUFACTURER NUMBERS
1S5-070 PISTON ASB-08-7-134	 10.0 5.5	AS2-08-5-007 .375-16 UNC 2.65	 .750 smooth outside .125-27 NPTF inside 2.12	VOLVO 8169029
1S5-072 PISTON ASC-08-7-219	 10.5 4.0	AS2-08-5-066 .750 smooth 2.65	 .750 smooth outside .125-27 NPTF inside 2.12	FLEETRITE 1S5-072 INT'L / NAVISTAR 2012771C1
1S5-120 PISTON ASC-08-7-194	 10.5 4.0	ASB-08-5-129 .750-16 UNF outside .125-27 NPTF inside 2.65	 .500-13 UNC 2.12	FIRESTONE 7014 7017 7042 7044 W023587014 W023587017 W023587042 W023587044
1S5-122 PISTON ASC-08-7-213	 10.5 4.0	ASB-08-5-145 .75-16 UNF 3.15	 .750 smooth outside .125 NPTF inside 3.53	
1S5-133 PISTON ASC-08-7-157	 6.25 2.2	ASB-08-5-076 .750 smooth outside .125-27 NPTF inside 2.65	 .375-16 UNC 3.25	LINK CAB & SEAT SPRINGS 1101-0045

● Bolt or Stud – 1/2-13 or 1/2-20

⊗ Air Fitting – 1/4 NPTF

⊙ Stud – 3/4-10

⊕ Tapped Hole on Top Retainers – 3/8-16, on Pistons – 1/2-13

⊗ Air Fitting – 1/2 NPTF or 3/8 NPTF



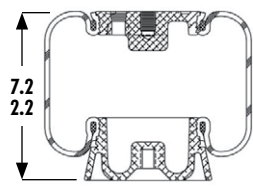
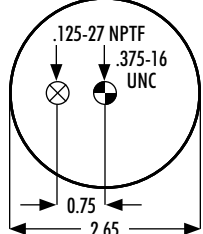
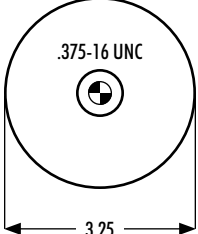
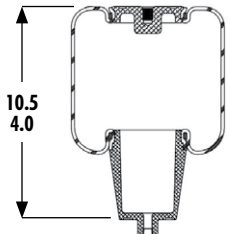
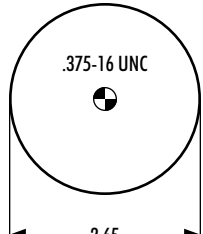
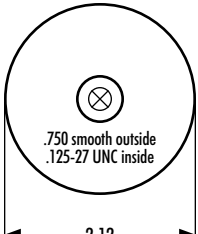
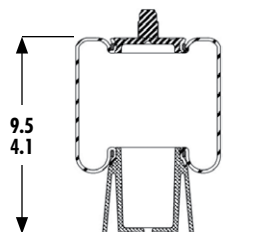
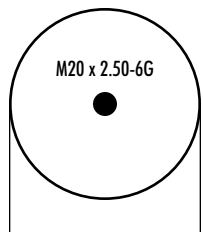
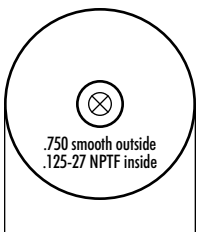
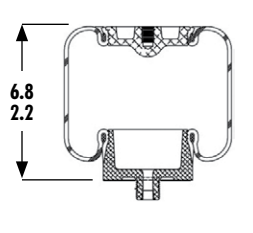
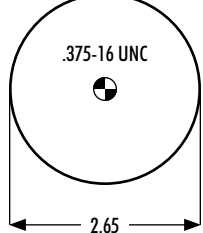
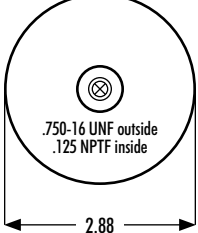
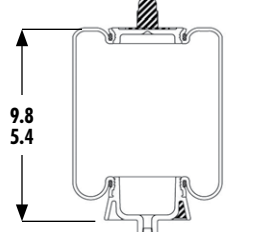
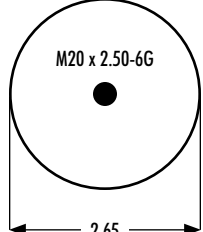
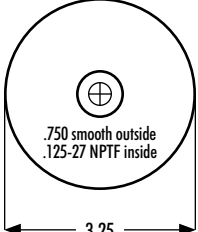

⊗ Combination Stud Air Fitting: Stud – 3/4-16, Air Fitting – 1/4 NPTF

AIR SPRING SLEEVES

PART NUMBER	SIDE VIEW WITH EXTENDED AND COMPRESSED HEIGHT	UPPER MOUNTING VIEW	LOWER MOUNTING VIEW	MANUFACTURER NUMBERS
1S5-135 PISTON ASC-08-7-157		ASB-08-5-170 		LINK CAB & SEAT SPRINGS 1101-0044
1S5-152 PISTON ASC-08-7-219		AS2-08-5-112 		FIRESTONE 7110 W023587110
1S5-154 PISTON ASC-08-7-213		ASB-08-5-190 		MACK TRUCK 227QS3128M
1S5-157 PISTON ASC-08-7-006		AS2-08-5-007 		FIRESTONE 7064 LINK CAB & SEAT SPRINGS 1102-0074
1S5-164 PISTON ASC-08-7-137		ASB-08-5-190 		MACK TRUCK 227QS47M

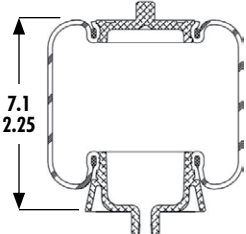
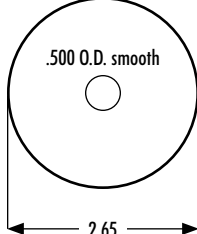
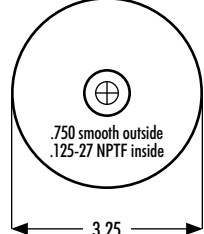
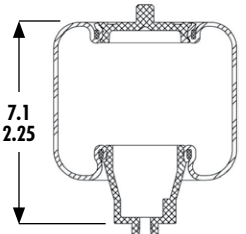
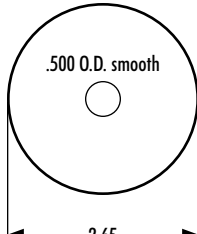
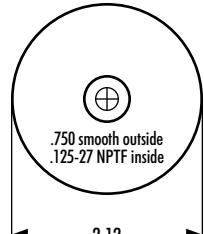
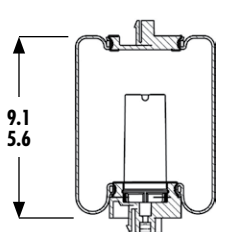
- Bolt or Stud – 1/2-13 or 1/2-20
- ⊗ Air Fitting – 1/4 NPTF
- ⊙ Stud – 3/4-10
- ⊕ Tapped Hole on Top Retainers – 3/8-16, on Pistons – 1/2-13
- ⊗ Air Fitting – 1/2 NPTF or 3/8 NPTF
- ⊙ Combination Stud Air Fitting: Stud – 3/4-16, Air Fitting – 1/4 NPTF

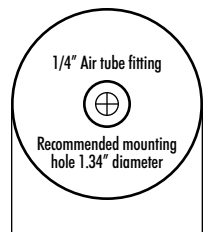
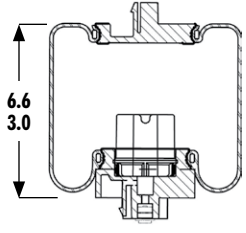
AIR SPRING SLEEVES

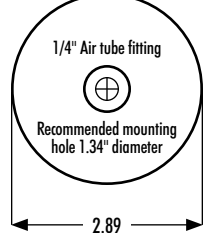
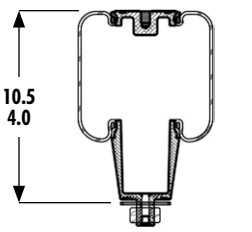
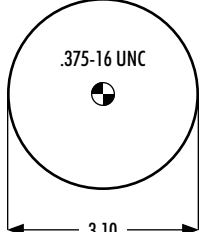
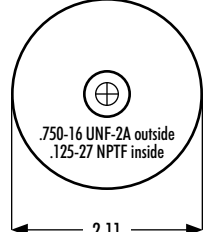
PART NUMBER	SIDE VIEW WITH EXTENDED AND COMPRESSED HEIGHT	UPPER MOUNTING VIEW	LOWER MOUNTING VIEW	MANUFACTURER NUMBERS
1S5-173 PISTON ASC-08-7-137		ASB-08-5-132 		FREIGHTLINER 18-41909-0
1S5-174 PISTON ASC-08-7-232		ASB-08-5-132 		
1S5-175 FLEXMEMBER 579-10-1-116 PISTON ASC-08-7-277		ASB-08-5-176 		CONTI 67451 67638 68161 SC31-B207 SC31-Y205 SC31-Y215 FREIGHTLINER 18-40977-000 18-52651-000 FIRESTONE 7205 7207 7215 W023587205 W023587207 W023587215 TRP AS72150
1S5-176 FLEXMEMBER 579-10-1-115 PISTON ASC-08-7-277		ASB-08-5-176 		CONTI 67452 SC31-W206 FIRESTONE 7202 7206 W023587202 W023587206 FREIGHTLINER 18-29919-000 TRP AS72060
1S5-186 FLEXMEMBER 579-10-1-083 PISTON 579-08-7-301		579-08-5-112 		CONTI 68162 SC29-Y036 FIRESTONE 7036 W023587036 PETERBILT 2903200 TRP AS70360

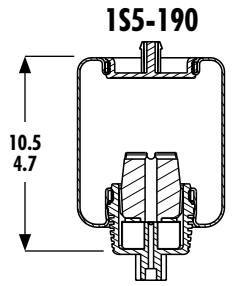
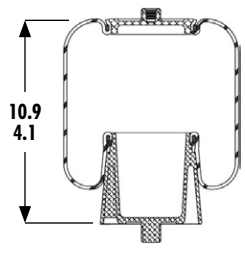
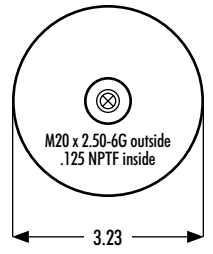
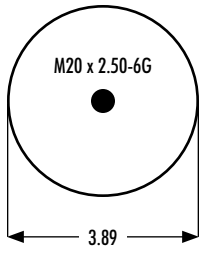
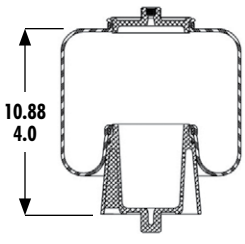
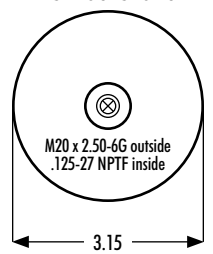
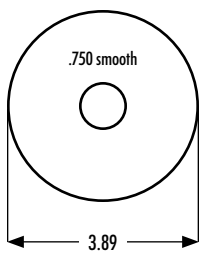
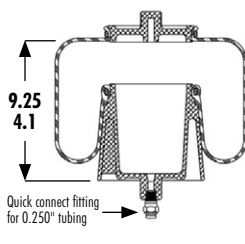
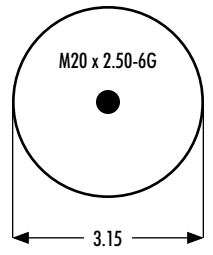
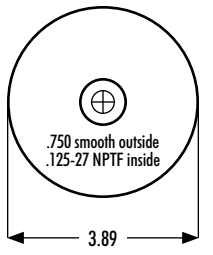
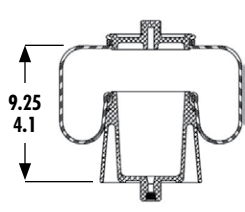
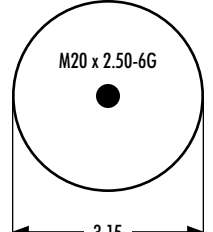
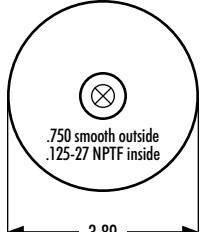

- Bolt or Stud – 1/2-13 or 1/2-20
- ⊗ Air Fitting – 1/4 NPTF
- ⊙ Stud – 3/4-10
- ⊕ Tapped Hole on Top Retainers – 3/8-16, on Pistons – 1/2-13
- ⊗ Air Fitting – 1/2 NPTF or 3/8 NPTF
- ⊙ Combination Stud Air Fitting: Stud – 3/4-16, Air Fitting – 1/4 NPTF

AIR SPRING SLEEVES

PART NUMBER	SIDE VIEW WITH EXTENDED AND COMPRESSED HEIGHT	UPPER MOUNTING VIEW	LOWER MOUNTING VIEW	MANUFACTURER NUMBERS
1S5-190 BELLOWS 580-23-4-604 FLEXMEMBER 579-10-1-123 PISTON 579-08-7-312			579-08-7-312	FIRESTONE W02-358-7093 PETERBILT 29-06016
1S6-023 PISTON ASB-08-7-079		ASB-08-5-048 		
1S6-026 PISTON ASC-08-7-223		AS2-08-5-048 		MACK TRUCK 227QS3108M
1S6-031 PISTON ASC-08-7-215		ASB-08-5-146 		FREIGHTLINER GYR1S6031
1S6-033 PISTON ASC-08-7-215		ASB-08-5-146 		

- Bolt or Stud – 1/2-13 or 1/2-20
- ⊗ Air Fitting – 1/4 NPTF
- ⊙ Stud – 3/4-10
- ⊕ Tapped Hole on Top Retainers – 3/8-16, on Pistons – 1/2-13
- ⊗ Air Fitting – 1/2 NPTF or 3/8 NPTF
- ⊙ Combination Stud Air Fitting: Stud – 3/4-16, Air Fitting – 1/4 NPTF

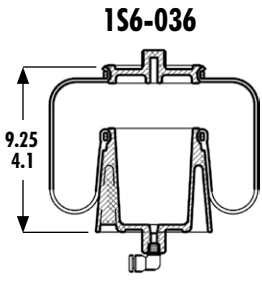
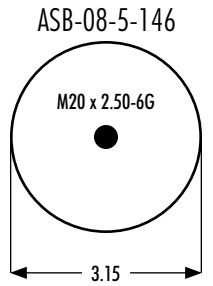
AIR SPRING SLEEVES

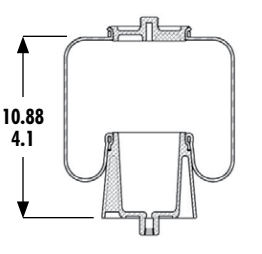
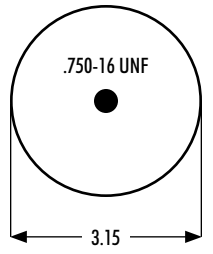
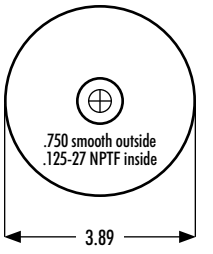
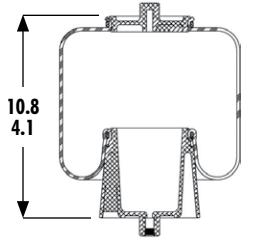
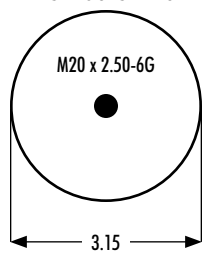
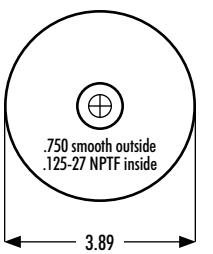
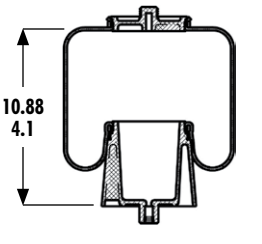
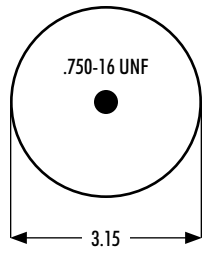
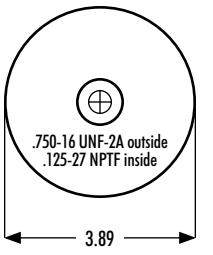
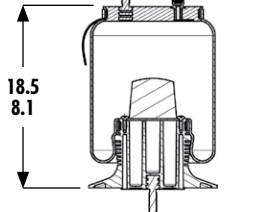
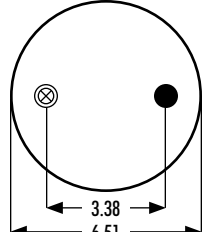
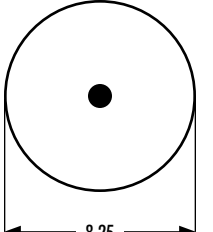
PART NUMBER	SIDE VIEW WITH EXTENDED AND COMPRESSED HEIGHT	UPPER MOUNTING VIEW	LOWER MOUNTING VIEW	MANUFACTURER NUMBERS
1S6-036 PISTON 579-08-7-215		ASB-08-5-146 		
1S6-046 PISTON ASC-08-7-215		ASB-08-5-145 		LINK CAB & SEAT SPRINGS 1101-0060
1S6-055 PISTON ASC-08-7-215		ASB-08-5-146 		
1S6-641 PISTON 566-08-7-215		ASB-08-5-145 		
1S8-003 FLEXMEMBER 579-16-1-002 PISTON 579-16-7-103		579-16-5-001 		

- Bolt or Stud – 1/2-13 or 1/2-20
- ⊗ Air Fitting – 1/4 NPTF
- ⊙ Stud – 3/4-10
- ⊕ Tapped Hole on Top Retainers – 3/8-16, on Pistons – 1/2-13
- ⊗ Air Fitting – 1/2 NPTF or 3/8 NPTF
- ⊙ Combination Stud Air Fitting: Stud – 3/4-16, Air Fitting – 1/4 NPTF

AIR SPRING SLEEVES

PISTON INDEX

PISTON #	FLEX MEMBER #	AIR SPRINGS #
566-20-7-240	566-24-3-048	1R12-511
566-20-7-240	566-24-3-038	1R12-396
566-20-7-240	566-24-3-048	1R12-304
566-20-7-240	566-24-3-048	1R12-284
566-20-7-240	566-24-3-024	1R12-127
566-20-7-240	566-22-3-049	1R11-189
566-20-7-240	566-22-3-143	1R11-170
566-20-7-240	566-22-3-143	1R11-147
566-20-7-240	566-22-3-143	1R11-143
566-20-7-240	566-20-3-023	1R10-137
566-20-7-240	566-20-3-021	1R10-133
566-20-7-240	566-20-3-021	1R10-127
566-20-7-240	566-20-3-021	1R10-120
566-20-7-240	566-20-3-021	1R10-118
566-20-7-240	566-20-3-021	1R10-105
566-20-7-240	566-20-3-021	1R10-099
566-20-7-240	566-20-3-021	1R10-091
566-20-7-240	566-20-3-021	1R10-089
566-20-7-240	566-20-3-021	1R10-087
566-20-7-240	566-20-3-022	1R10-019
566-20-7-240	566-22-3-143	1R11-094
566-20-7-240	566-20-3-021	1R10-165
566-20-7-246	566-24-3-038	1R12-462
566-20-7-246	566-24-3-097	1R12-424
566-20-7-246	566-24-3-038	1R12-423
566-20-7-246	566-24-3-097	1R12-404
566-20-7-246	566-24-3-097	1R12-402
566-20-7-246	566-24-3-038	1R12-400
566-20-7-250	566-22-3-143	1R11-169
566-20-7-251	566-24-3-076	1R12-616
566-20-7-251	566-24-3-067	1R12-562
566-20-7-251	566-24-3-061	1R12-539
566-20-7-251	566-24-3-061	1R12-531
566-20-7-251	566-24-3-061	1R12-530
566-20-7-251	566-24-3-067	1R12-508
566-20-7-251	566-22-3-021	1R11-203
566-20-7-252	566-24-3-067	1R12-563
566-20-7-252	566-24-3-067	1R12-559
566-20-7-252	566-24-3-067	1R12-558
566-20-7-252	566-24-3-067	1R12-557
566-20-7-252	566-24-3-067	1R12-556
566-20-7-252	566-22-3-021	1R11-242
566-20-7-252	566-22-3-021	1R11-202
566-20-7-252	566-22-3-021	1R11-201
566-20-7-252	566-22-3-021	1R11-200
566-20-7-253	566-24-3-067	1R12-561
566-20-7-253	566-24-3-067	1R12-560
566-20-7-253	566-24-3-067	1R12-555
566-20-7-253	566-22-3-143	1R11-241
566-20-7-253	566-22-3-057	1R11-225
566-20-7-253	566-22-3-021	1R11-205
566-20-7-253	566-22-3-021	1R11-204
566-20-7-257	566-22-3-068	1R11-216
566-20-7-257	566-22-3-075	1R11-176
566-20-7-257	566-22-3-060	1R11-175
566-20-7-274	566-28-3-057	1R14-236
566-20-7-274	566-26-3-095	1R13-235
566-20-7-276	566-28-3-021	1R14-218
566-20-7-276	566-28-3-021	1R14-177
566-20-7-277	566-26-3-097	1R13-237
566-20-7-277	566-28-3-059	1R14-240
566-20-7-286	566-28-3-021	1R11-222
566-20-7-286	566-28-3-021	1R11-220
566-20-7-287	566-28-3-021	1R11-221
566-20-7-287	566-22-3-021	1R11-219

*The prefixes ASC, ASD, AS3 OR AS4 may be used interchangeably with 566 and may appear on some flex members or pistons.

PISTON #	FLEX MEMBER #	AIR SPRINGS #
566-20-7-287	566-22-3-021	1R11-268
566-20-7-296	566-26-3-081	1R13-109
566-20-7-296	566-26-3-081	1R13-097
566-20-7-299	566-24-3-117	1R12-580
566-20-7-303	566-24-3-097	1R12-647
566-20-7-303	566-24-3-164	1R12-615
566-20-7-304	566-28-3-043	1R14-182
566-20-7-308	566-22-3-073	1R11-224
566-20-7-314	566-26-3-078	1R13-188
566-20-7-322	566-24-3-108	1R12-603
566-20-7-323	566-28-3-042	1R14-232
566-20-7-325	566-26-3-068	1R13-118
566-20-7-327	566-28-3-021	1R14-215
566-20-7-327	566-26-3-051	1R13-039
566-20-7-328	566-22-3-143	1R11-267
566-20-7-328	566-22-3-076	1R11-266
566-20-7-334	566-28-3-015	1R14-198
566-20-7-334	566-28-3-024	1R14-179
566-20-7-334	566-28-3-042	1R14-175
566-20-7-334	566-28-3-015	1R14-108
566-20-7-334	566-28-3-015	1R14-052
566-20-7-334	566-28-3-065	1R14-039
566-20-7-334	566-28-3-015	1R14-038
566-20-7-334	566-28-3-015	1R14-037
566-20-7-334	566-26-3-069	1R13-151
566-20-7-334	566-26-3-054	1R13-120
566-20-7-334	566-28-3-015	1R14-216
566-20-7-334	566-26-3-015	1R14-155
566-20-7-334	566-28-3-015	1R14-094
566-20-7-334	566-28-3-015	1R14-042
566-20-7-377	566-24-3-140	1R12-403
566-20-7-387	566-20-3-021	1R10-171
566-20-7-392	566-22-3-143	1R11-273
566-20-7-413	566-24-3-142	1R12-1047
579-08-7-157		1S5-057
579-08-7-215		1S6-036
579-08-7-219		1S4.5-113
579-08-7-301	579-10-1-083	1S5-186
579-16-7-103	579-16-1-002	1S8-003
AS3-08-7-006		1S5-157
ASB-06-7-014		1S3-011
ASB-08-7-079		1S6-023
ASB-08-7-134		1S5-070
ASC-06-7-017		1S3-013
ASC-08-7-005		1S5-006
ASC-08-7-005		1S5-005
ASC-08-7-005		1S4-008
ASC-08-7-093		1S4-030
ASC-08-7-134		1S4-074
ASC-08-7-137		1S5-173
ASC-08-7-137		1S5-040
ASC-08-7-137		1S4-067
ASC-08-7-137		1S4-016
ASC-08-7-137		1S5-164
ASC-08-7-137		1S4-173
ASC-08-7-139		1S5-045
ASC-08-7-139		1S5-010
ASC-08-7-139		1S4-058
ASC-08-7-139		1S4-007
ASC-08-7-157		1S5-135
ASC-08-7-157		1S5-133
ASC-08-7-157		1S4.5-179
ASC-08-7-157		1S4.5-121
ASC-08-7-157		1S4-175
ASC-08-7-157		1S4-123

PISTON INDEX CONT.

PISTON #	FLEX MEMBER #	AIR SPRINGS #
ASC-08-7-163		1S4-035
ASC-08-7-163		1S5-032
ASC-08-7-194		1S5-120
ASC-08-7-194		1S5-061
ASC-08-7-194		1S5-055
ASC-08-7-194		1S5-038
ASC-08-7-194		1S4.5-107
ASC-08-7-194		1S4.5-073
ASC-08-7-194		1S4-056
ASC-08-7-194		1S4-044
ASC-08-7-213		1S5-154
ASC-08-7-213		1S5-122
ASC-08-7-215		1S6-046
ASC-08-7-215		1S6-033
ASC-08-7-215		1S6-031
ASC-08-7-215		1S6-055
ASC-08-7-219		1S5-152
ASC-08-7-219		1S5-072
ASC-08-7-219		1S5-060
ASC-08-7-219		1S4-042
ASC-08-7-223		1S6-026
ASC-08-7-232		1S5-174
ASC-08-7-277	579-10-1-115	1S5-176
ASC-08-7-277	579-10-1-116	1S5-175
Not Included	566-18-3-004	1R9-047
Not Included	566-28-3-020	1R14-060
Not Included	566-28-3-020	1R14-031
Not Included	566-28-3-020	1R14-025
Not Included	566-26-3-051	1R13-049
Not Included	566-26-3-072	1R13-048
Not Included	566-24-3-038	1R12-394
Not Included	566-24-3-066	1R12-113
Not Included	566-24-3-067	1R12-097
Not Included	566-24-3-038	1R12-093
Not Included	566-20-3-021	1R10-085
Not Included	566-20-3-022	1R10-030

*The prefixes ASC, ASD, AS3 OR AS4 may be used interchangeably with 566 and may appear on some flex members or pistons.

CROSS REFERENCE INFORMATION CONT.

COMPETITOR BELLOWS #	COMPETITOR #	GOODYEAR #	PAGE #
WATSON & CHALIN CONT.			
	AS-0035	2B9-210	21
	AS-0041	2B9-250	23
	AS-0048	3B12-319	38
	AS-0048-1F	3B12-329	39
	AS-0048-2G	3B12-324	38
	AS-0048-3G	3B12-342	39
	AS-0058	2B9-229	25
	AS-0075	3B12-303	37
	AS-0086	3B14-452	16
	AS-0087	2B12-346	33
	AS-0087-1F	2B12-345	33
	AS-0088	2B9-245	22
	AS-0089	2B14-383	36
	AS-0010	1R14-028	117
	AS-0011	1R12-092	100
	AS-0012	1R12-095	83
	AS-0013	1R13-039	104
	AS-0015	1R12-132	88
	AS-0017	1R11-028	53
	AS-0018	1R12-066	66
	AS-0023	1R13-038	108
	AS-0023-1G	1R14-154	115
	AS-0026	1R9-065	46
	AS-0028	1R12-066	66
	AS-0029	1R9-070	48
	AS-0036	1R12-335	93
	AS-0039	1R14-039	123
	AS-0040	1R12-103	78
	AS-0044	1R12-421	49
	AS-0047	1R14-174	116
	AS-0047G	1R14-170	115
	AS-0049	1R12-441	70
	AS-0050	1R12-370	89
	AS-0053	1R12-370	89
	AS-0054	1R12-487	85
	AS-0056	1R12-439	81
	AS-0057	1R12-580	99
	AS-0061	1R12-480	81
	AS-0073	1R13-120	106
	AS-0077	1R12-069	66
	AS-0077	1R12-669	75
	AS-0078	1R14-042	112
	AS-0082	1R14-038	112
	AS-0083	1R13-039	104
	AS-0084	1R13-239	111
	AS-0090	1R12-502	72
	AS-0095	1R12-309	84
	AS-0096	1R13-115	103
	AS0098	1R13-207	110
	AS-0101	1R12-356	68
	AS-0104	1R12-256	93
	AS-0107G	1R13-155	105
	AS-0113G	1R12-541	73
	AS-0114G	1R12-540	99
	AS-0144	1R14-190	122
	AS-0241	1R14-232	121
	AS-0246	1R14-236	122

NOTES

REFERENCE

INFINITY ENGINEERED PRODUCTS STANDARD TERMS AND CONDITIONS OF SALE

Definitions:

- “Buyer” means Infinity Engineered Products and “Seller” means the legal entity contracting with the Buyer.
- “Order” and “Purchase Order” are used synonymously.
- “Delivery Date” means the required date of delivery for Goods on the Purchase Order or Blanket Order Release; or the acceptance in total of the Services provided by the Seller.

2. Acceptance, Modification, and Entire Agreement: Placement of this order constitutes Buyer’s offer to Seller upon terms and conditions stated herein and on the face of the purchase order and does not constitute an acceptance by the Buyer of any offer to sell. This order becomes a binding contract, subject to the terms and conditions thereof, when accepted by acknowledgment or commencement of performance and is binding on the heirs, successors, assigns, and representatives of the Seller. Placement of this order is expressly conditioned upon Seller’s acceptance of all the terms and conditions of purchase contained on or attached to this order. Any acknowledgment form or other form of Seller containing terms and conditions of sale submitted to Buyer from Seller shall not have the effect of modifying the terms and conditions hereof. Any such additional or different terms and conditions are hereby objected to and rejected by the Buyer. Buyer may consider Seller’s request for changes only if such request is made in writing and directed to specific clauses in this order within ten (10) days of issuance of this order. By acceptance of the order, Seller agrees to comply with the terms and conditions contained herein and to provide all Goods and/or Services as described within the purchase order. These terms and conditions constitute the entire agreement between the parties and supersede any previous oral or written representations, including but not limited to provisions in Seller’s quotations, proposals, terms and conditions, acknowledgments, invoices or other documents. No change or modification to Buyers terms and conditions shall be binding upon Buyer unless specifically accepted in writing.

3. Delivery: Time is of the essence in regard to fulfilling this order. Seller shall deliver the Goods and/or Services ordered by Buyer no later than the Delivery Date. Seller shall immediately notify Buyer in the event that Seller’s performance is delayed or likely to be delayed, in whole or in part, and Seller shall provide Buyer with all information regarding any reasons for such delay. Such notice shall not constitute a waiver by Buyer of any Seller’s obligations under the purchase order. Buyer has the right to cancel all or a portion of this order which has not been delivered in accordance with the Delivery Date. Seller will limit and phase expenditures, incurrence of costs, and purchases and subcontract commitments for raw materials and components in such fashion to ensure continuity in production and permit transportation and completion of each production increment in sequence without creating any unreasonable accumulations of raw materials or work in process of components for any production increments. If the specified mode of transportation for the Goods would not permit the Seller to meet the Delivery Date, Seller shall ship Goods by air freight or other expedient means acceptable to the Buyer and Seller shall pay the costs of such freight for such expedited shipment, over the cost of the specified mode of transportation. Seller shall be liable for any production line stoppages or related expenditures incurred by Buyer or charged to Buyer by its customers, which are caused by the failure of Seller to deliver its Goods and/or Services in a timely manner. Default in delivery caused by Acts of God or other extraordinary events or occurrences beyond Seller’s control and without its fault or negligence shall not make Seller liable therefore, provided Seller immediately notifies Buyer of said event and the estimated delay in delivery. If the Goods and/or Services ordered by Buyer are in excess of the volume stated on the order, and/or its releases, or are delivered more than five (5) days prior to the Delivery Date, Buyer may reject such delivery of Goods and/or Services and may return such rejected Goods at Seller’s own risk and expense, including, without limitation, transportation and insurance charges. Buyer may delay delivery or acceptance occasioned by reason of force majeure or other causes beyond its control. Seller shall hold such Goods at the direction of the Buyer and shall deliver them when the cause affecting delay has been removed. Causes beyond Buyer’s control include, without limitation, government action or failure of the government to act where such action is required, strike or other labor issues, fire, destruction or impairment of facilities, or Acts of God.

4. Default of Seller: If Seller shall (a) fail to deliver Goods and/or Services within the time scheduled or in compliance to the Delivery Date or (b) fail to perform any other provision of this order or (c) become insolvent, or (d) file or have filed against it a petition under any state or federal bankruptcy or insolvency law, then, and in any such event, without prejudice to Buyer’s other rights or remedies Buyer shall have the right at its option to terminate this order, in whole or in part. Upon any such termination Buyer may exercise any and all rights accruing to it, both at law including those set forth in the Uniform Commercial Code or in equity and may also (1) require Seller to deliver forthwith any or all Goods , or parts thereof, which have been produced, or are in process of production pursuant to this order, in which event Buyer shall pay Seller the order price for the acceptable completed items so delivered and shall reimburse Seller for its costs actually incurred with respect to the partially completed Goods so delivered, provided that such costs in no event shall exceed the order price equitably allocated therefore and (2) procure, for such items and in such manner as it may deem appropriate, Goods and/or Services similar to those terminated, and to recover from Seller the excess cost incurred by Buyer in procuring such similar Goods and/or Services. Seller’s obligations under the Warranty, Patent and Confidentiality provisions of this order shall survive such termination.

5. Price: This is a firm price order. Seller represents and warrants to Buyer that the price for Goods and/or Services provided under the purchase order are the lowest prices, whether or not published,

for which the Seller has sold or is selling such Goods and/or Services, taking into account any differences in quantities and/or delivery schedule. Buyer shall be entitled to receive from Seller a price reduction if Seller offers substantially similar Goods or Services to others at a lower price (taking into account differences in quantities and delivery schedule) at any time during the period beginning on the date of the order and ending ninety (90) days after the final payment due date for such Goods or Services. Buyer may take volume discounts retroactively.

All payments due under the purchase order to Seller shall be paid in United States dollars as agreed by Buyer and Seller, from the date of invoice from the Seller. Partial payments may be made at Buyer’s option. Buyer may set-off any amount owed by Buyer to Seller against any amount owed Buyer from Seller. Seller’s acceptance of payment constitutes an unconditional waiver and release of any statutory lien, mechanic’s lien, stop notice, bond right, and claim for payment. Seller warrants, represents and covenants that when final payment is accepted from Buyer, title to all work, materials, and/or equipment shall pass to Buyer free and clear of all liens, claims, security interests or any other encumbrances; and all applicable taxes have been fully paid; and all laborers, mechanics, and subcontractors have been paid or will be paid in full from the final payment. Seller shall pay, without charge to Buyer, any federal, state or local tax or other government charge or assessment relating to the production, sale or shipment of any Goods or provision of Services under the purchase order unless otherwise expressly agreed to in writing by the Buyer. Seller shall make spare parts for Goods purchased pursuant to the order available to the Buyer at Seller’s current price, less all applicable discounts. All costs associated with custom product tooling shall be paid by Seller, unless otherwise expressly agreed to in writing by Buyer. Seller shall bear responsibility for all errors contained in any invoice, acceptance, acknowledgment or confirmation it provides to the Buyer.

6. Changes: Buyer may make changes in the drawings and specifications on any item at any time. If such changes result in delay or additional expense to Seller, an equitable adjustment of price and delivery schedule will be made.

7. Specifications: If drawings, blueprints, or specifications are furnished by the Buyer, the purchase order shall be based upon such drawings, blueprints, or such specifications, and approval of samples by Buyer shall not relieve the Seller from strict and full compliance with such blueprints or specifications. Goods and/or Services not conforming to such blueprints or specifications may be rejected.

8. Inspection / Acceptance: Seller agrees to permit Buyer’s inspectors to have access to Seller’s plant at all reasonable times for the purpose of inspecting the items as set forth in this order and work in process for production of such items. All items are subject to final inspection and approval at Buyer’s facilities or other place designated by Buyer. Such inspection shall be made within a reasonable time after delivery irrespective of the date of payment. The date of payment and the payment for any item purchased hereunder shall not constitute approval or acceptance of such material by Buyer and Buyer’s right of inspection shall survive payment. Any inspection records relating to the Goods and/or Services on the order shall be available to Buyer for a minimum of one (1) year after delivery to Buyer. No inspection (including source inspection) test, approval (including design approval) or acceptance of Materials shall relieve the Vendor from its obligations hereunder or be deemed acceptance of the Materials. Buyer may (1) assess Seller a fee associated with the delivery of defective Goods (2) assess the Seller for all incurred costs and may (3) return rejected items at Seller’s expense and Seller shall bear all costs of return and risk of loss as to rejected items. Seller shall, at Buyer’s election, replace any rejected items returned to Seller hereunder, refund the full purchase price thereof and bear the costs associated with any air freight or expedited delivery to the Buyer of conforming product to remedy any defects of nonconformity to specifications, drawings, or provided samples.

9. Packaging and Shipping: All items shall be prepared and packed for shipment in a manner that will prevent damage in transit. Buyer is not liable for extra charges for packing, cartage or any other expense related thereto unless stated in this order. Seller shall provide Buyer’s part number, order number, line number and release number on all invoices, packing slips, container labels and any other shipping documentation.

10. Warranty: Seller warrants that all goods and/or services provided by it (i) shall be of good quality and workmanship and free of defects, latent or patent; (ii) shall conform to all specifications, drawings or descriptions which are supplied by Buyer; (iii) shall be merchantable and suitable and sufficient for their intended purpose; and (iv) shall be free from any claim of any third party., including without limitation any claims of infringement. Seller may not negate, exclude, limit or modify any warranty otherwise available to Buyer. Any attempt by Seller to do so is ineffective and shall not in any way bind Buyer. Buyer’s inspection or acceptance of any goods or services, or Buyer’s payment for goods or services shall not constitute a waiver by it of any warranty. None of the remedies available to Buyer for breach of any of the forgoing warranties may be limited except to the extent and in the manner agreed upon by Buyer in a separate written agreement specifically designating such limitation and signed by an authorized representative of Buyer.

11. Cancellation, Termination for Convenience: Buyer reserves the right to cancel this purchase order, or any part thereof, at any time, even though Seller is not in default hereunder, by giving written notice to the Seller in the event of such cancellation. Buyer shall pay for all goods and services delivered and completed and an equitable settlement shall be arrived at for the costs incurred by Seller for goods and materials in process not to exceed thirty (30) days average procurement by the Buyer over the previous ninety (90) days prior to notification. Where cancellation is by reason of termination of a contract of the United States Government under which

this purchase order has been placed, Buyer will pay the Seller at such time as Buyer is paid by the United States Government. Upon receipt of any notice of cancellation hereunder, Seller, unless otherwise directed, will immediately discontinue all work in process and immediately cancel all orders or subcontracts given or made pursuant to this purchase order. Exercise by Buyer of the rights of cancellation reserved in this paragraph shall give rise to no liability on the part of the Buyer except as specified in this paragraph and shall not have the effect of waiving damages the Buyer might otherwise be entitled to.

12. Patent, Trademark, Copyright Indemnity: Seller agrees to indemnify Buyer and its successors, assigns and customers and hold them harmless from and against all claims, liability, loss, damage or expense, including attorney’s fees and expenses, arising from or by reason of any suit, claim or demand relating to trademark, patent or copyright infringement or litigation based hereon with respect to the Goods and/or Services, or any part thereof, covered by this order and such obligations shall survive acceptance of the Goods and/or Services and payment thereof by the Buyer. Seller agrees that it will assume the defense of the Buyer and/or its successors, assigns and customers and users of its products against any such aforementioned suit, claim, or demand, pendency of any such suit, claim or demand; provided that it is given reasonable notice of the pendency of any such suit, claim, or demand.

13. Indemnity: Seller will indemnify, defend and hold harmless Buyer, its affiliates, successors and assigns, and its and their respective officers, directors, employees, independent contractors, agents, successors and assigns (collectively, the “Indemnified Parties”), from and against any and all liabilities, losses, costs, expenses, claims and proceedings which any of the Indemnified Parties may suffer or for which any of the Indemnified Parties may become liable and which arise out of any of the following; Seller’s breach of any provision herein or any other agreement between Buyer and Seller; the manufacture or delivery of Goods or any defect in the Goods and/or Services, workmanship or otherwise; any act or omission of the Seller; any actual or alleged infringements of any intellectual property right of any other party, resulting from any sale, use or manufacture of any Goods delivered hereunder; Seller’s failure to comply with any federal, state, county or local laws, ordinance, regulations and codes; and any and all actions, suits, proceedings, demands, assessments, judgments, costs and expenses, including reasonable attorneys’ and consultants’ fees incident to any of the foregoing. If there is a claim against Buyer arising out of the foregoing, Seller will have the right, at its option and expense, to defend any such proceeding, claim or demand. If Seller defends such claim, Buyer shall still have the right, at its cost and expense, to participate in the defense with counsel of its own choosing. Buyer may retain counsel and conduct the defense of the proceeding, claim or demand in question as it may deem proper in its sole discretion, at the sole cost and expense of Seller. Seller may not settle any such proceeding, claim or demand without Buyer’s consent, which shall not be unreasonably withheld.

14. Subcontract, Assignment: Seller shall not, without the prior written consent of Buyer, make any contract with any other legal entity for furnishing any of the completed or substantially completed Goods and/or Services covered by this order or assign this order or any right hereunder.

15. Buyer’s Property: All tools, dies, jigs, patterns, equipment or material and other items purchased, furnished, charged to or paid for by Buyer and any replacement thereof, shall remain the property of Buyer. Such property shall be plainly marked to show it is the property of Buyer and shall be safely stored and maintained apart from other property held by Seller. Seller shall not substitute the property for Buyer’s property and shall not use such property except in filling Buyer’s orders. Seller shall hold such property at its own risk and upon Buyer’s written request deliver the property to Buyer in the same condition as originally received by Seller, reasonable wear and tear excepted. Title to and right of possession to special tooling, dies, jigs, patterns and equipment, the cost of which is fully or substantially amortized in the price of the Goods purchased, shall remain with Seller but Seller shall, at no additional cost to Buyer, hold such special tooling for Buyer’s exclusive use and Seller shall not dispose of such tooling without prior written approval of Buyer. Seller shall take all necessary measures to preserve Buyer’s title to Buyer’s property, free of all encumbrances. Buyer retains the right in addition to other rights provided by law, to enter Seller’s premises and remove Buyer-owned property with or without a court order. Seller shall assume and shall indemnify Buyer against any and all liability for damages to property or injury to, or death of any persons which may arise from, may be incidental to the presence of, or may involve the use of Buyer-owned property whether such damage, injury or death is caused by defects in the property, negligence in the use thereof or otherwise.

16. Drawings, Specifications and Technical Information: The ideas, information and designs contained in or shown upon, and the drawings, specifications, photographs and other engineering and manufacturing information supplied by Buyer shall remain Buyer’s property, shall be retained in confidence by Seller and not be disclosed to any other person or entity, and shall not be used nor incorporated into any product or item later manufactured or assembled by Seller for anyone other than Buyer. Any unpatented knowledge or information concerning Seller’s processes, present or contemplated products or their uses, which Seller may disclose to employees of Buyer in connection with the ordering, acquisition and use by Buyer of the goods or services covered by this order shall, unless otherwise specifically agreed in writing, be deemed to have been disclosed as part of the consideration for this order and Seller agrees not to assert any claim against Buyer by reason of any alleged use to which any such information or knowledge may be put by Buyer.

17. Chemical Substances: Not withstanding anything to the contrary hereafter represented by either party to the other, Seller warrants that each and every chemical substance sold or otherwise transferred by Seller to Buyer as of the time of such sale or transfer that is required or permitted to be reported for the inventory of chemical substances (409 CFR Part 710) has been reported to EPA either by Seller or by others for incorporation in the inventory of chemical substances compiled and published by the administrator of the Environmental Protection Agency pursuant to the Federal Toxic substances Control Act (PL 94-469).

18. Hazardous Materials: Seller shall notify Buyer of any inherent hazard related to any materials which could be exposed during handling, transportation, storage, use, resale, disposal or scrap. Said notice shall be sent to the Buyer’s Director of Supply Chain Management and shall specify the product name and part number, the nature of the hazard, proper precautions that must be undertaken by Buyer or others to protect against the hazard, and any additional information necessary to protect its interest.

19. Compliance with Law: Seller represents and warrants that the performance of this order in furnishing of goods and/or service called for shall be in accordance with the applicable standards, provisions and stipulations of all pertinent federal, state, or local laws, rules, regulations, executive orders or other ordinances, including but not limited to the Fair Labor Standards Act, as amended and of regulations and orders of the United States Department of Labor issued under Section XIV thereof, the Occupational Safety and Health Act of 1970, and the Toxic Substances Control Act, each as amended and in connection therein. Seller shall include the following legend on all invoices: “We hereby certify that the goods were produced in compliance with all applicable requirements of the Fair Labor Act, as amended, and of regulations and orders of the United States Department of Labor and that the goods as installed and/or used by Buyer will comply with the Occupational Safety and Health Act of 1970 as amended and the implementing rules and regulations promulgated by the Secretary of Labor”.

If Seller is providing goods to Buyer, Seller agrees to review and comply with Buyer’s conflict minerals policy statement (available at the url: <http://phx.corporate-ir.net/phoenix.zhtml?c=131738&p=irol-conflictMineral>) and to use commercially reasonable efforts to: (a) identify whether such goods contain tantalum, tin, tungsten or gold; (b) conduct a reasonable country of origin inquiry regarding the origin of such minerals in such goods to determine whether such minerals originated in covered countries, as defined in Section 1502 of the Dodd-Frank Wall Street Reform and Consumer Protection Act; (c) if such minerals originated in covered countries, conduct due diligence on the chain of custody of the source of such minerals for the purpose of identifying the smelter of said materials; and (d) assist Buyer in conducting reasonable due diligence concerning the smelters of such minerals. Seller shall include the substance of this Section in any agreement between Seller and its lower tier sellers and provide Buyer with reasonable documentation of Seller’s and its lower tier sellers’ due diligence efforts, in a format prescribed by Buyer, when requested by Buyer.

20. Equal Opportunity: During the performance of this order, the Seller shall comply with provisions of Executive Order 11246, including all amendments thereto relative to Equal Employment Opportunity and the implementing rules and regulations of the Department of Labor on Equal Opportunity Employment, all of which are incorporated herein by specific references and Seller shall on Buyer’s request, so certify.

21. Gratuities: Seller represents and warrants to Buyer that Seller has not offered or given any employee, agent, or representative of Buyer, or any government, any gratuity with the intent of securing any business from Buyer or favorable treatment under any agreement with Buyer. Any breach of this warranty shall be a material breach of the terms and conditions of each and every purchase order between Buyer and Seller.

22. Waiver: Failure of Buyer to insist on performance of any of these terms and conditions shall not be construed as a waiver of such items, conditions or requirements and shall not affect the right of Buyer thereafter to enforce each and every term, condition or requirement hereof.

23. Severability: If any language herein shall be invalidated for any reason, that language shall be considered deleted and the remainder shall be unaffected and shall continue in full force and effect to the fullest extent permitted by law.

24. Survival: The parties acknowledge and agree that the Terms and Conditions are intended to govern the rights, duties and obligations of the parties following the closing. Accordingly, this Agreement shall survive and shall not be deemed merged into, the execution or delivery of any Good and/or Service.

25. Cumulative Remedies: Nothing herein shall limit Buyer’s rights in law or equity for damages resulting from the delivery of any Goods and/or Services. The remedies provided herein are cumulative and are in addition to any other remedies provided at law, or in equity, and nothing herein shall be construed as prohibiting Buyer from pursuing any other remedies at law or in equity available to it for any breach or threatened breach of these Terms and Conditions, all of such remedies being cumulative in every respect. No waiver of any breach or violation hereof shall be implied from forbearance or failure by Buyer to take action thereon.

26. Choice of Law and Personal Jurisdiction: This contract is made in the County of Harrison and shall be governed and construed in accordance with the laws of the State of Texas. Any action relating to this contract shall be instituted and prosecuted in the courts of the County of Harrison, State of Texas or the United States District Court for the Eastern District of Texas. Seller agrees to submit to the exclusive jurisdiction of such courts and further agrees not to contest such venue as a forum non conveniens. Pending any decision, appeal or judgment in such proceedings or the settlement of any dispute arising under this order, Seller shall proceed diligently with the performance of the order in accordance with decision of the Buyer.

27. Miscellaneous:

- The relationship of Buyer and Seller is that of independent contractors.
- Unless authorized by Buyer in writing, the names of Buyer, its parent, subsidiaries and/or affiliated corporations or any of their trademarks shall not be used by Seller.
- No news release, public announcement, denial or confirmation of same or any part of the subject matter of this purchase order or any phase of this purchase order shall be made without the prior written approval of Buyer.



North America

Infinity Engineered Products
3524 Southwestern Blvd.
Fairlawn, OH 44333
234-466-7232
Customer Service — (800) 527-8492

www.infinityairsprings.com

The GOODYEAR trademark is used by Infinity Engineered Products under license from the Goodyear Tire & Rubber Company. © 2020 Infinity Engineered Products. All Rights Reserved. Printed in the USA.

INFINITY
ENGINEERED PRODUCTS